



**POLARIS**  
**RANGER**

2023

ACCESSORIES,  
GARAGE & APPAREL

EMEA VERSION



# HARDEST WORKING.

SMOOTHEST RIDING.



For the past two decades, RANGER has set the standard through unrivaled strength, unmatched capability and next-level comfort, making it the number one utility side-by-side for over 10-years running.

## 2023 LINEUP

### 1000 / XP 1000 / XP KINETIC / DIESEL

P. 16



RANGER 1000 EPS



RANGER CREW 1000 PREMIUM



RANGER 1000 PREMIUM  
NORDIC PRO



RANGER XP 1000 ABS



RANGER XP 1000 PREMIUM



RANGER CREW XP 1000 PREMIUM



RANGER XP 1000 PREMIUM  
HUNTER EDITION



RANGER XP 1000  
NORDIC PRO



RANGER DIESEL



RANGER DIESEL DELUXE



RANGER XP KINETIC  
PREMIUM



RANGER XP KINETIC  
ULTIMATE

### SP 570

P. 70



RANGER SP 570



RANGER SP 570  
HUNTER EDITION



RANGER SP 570  
NORDIC PRO

### YOUTH

P. 94

## CONTENTS

### 1000 / XP 1000 / XP KINETIC / DIESEL 16

ROOFS	18
WINDSHIELDS	20
REAR PANELS	22
DOORS	24
CAB KITS	26
CAB COMFORT & CONVENIENCE	28
WINCHES	30
PROTECTION	32
AUDIO	34
STORAGE	38

### COMMON ACCESSORIES 44

CONNECTED TECHNOLOGY	44
ELECTRICAL ACCESSORIES	46
COOLERS	48
HUNT	50
COLD WEATHER	52
PLOWS	54
LIGHTING	58
WHEELS & TIRES	60

### SP 570 70

ROOFS & DOORS	72
WINDSHIELDS & REAR PANELS	74
CAB KITS	76
AUDIO & CONVENIENCE	78
PROTECTION & WINCHES	79
STORAGE	80

### 500 / EV / 570 82

ROOFS & DOORS	84
WINDSHIELDS & REAR PANELS	86
CAB KITS	88
CONVENIENCE & PROTECTION	90
WINCHES	91
STORAGE	92

### YOUTH 94

### PARTS & GARAGE 96

MAINTENANCE	96
OIL & LUBRICANTS	98
MAINTENANCE FLUIDS	100
HD PARTS	102
SERVICE PARTS	104
CLEANERS & TRAILERING	106

### APPAREL 109

RACING COLLECTION	109
JERSEYS, GLOVES & HEATED APPAREL	111
HELMETS & GOGGLES	113
MEN'S APPAREL	115
BALL CAPS	118
CAMO APPAREL	119
WOMEN'S APPAREL	121
HOME & COLLECTIBLES	123



TAKE YOUR  
**2023 RANGER**  
TO THE NEXT LEVEL

Customize your experience by adding Cab Kits.



**RANGER 1000  
XP 1000 /  
XP KINETIC / DIESEL**

**CAB KITS AVAILABLE** P.26

FULL CAB PREMIUM  
FULL CAB NORDIC  
FULL CAB  
HALF CAB



**RANGER 570 SP**

**CAB KITS AVAILABLE** P.76

FULL CAB  
HALF CAB



**RANGER EV / 570**

**CAB KITS AVAILABLE** P.88

FULL CAB  
HALF CAB





**DESIGNED** by the people who designed your vehicle.

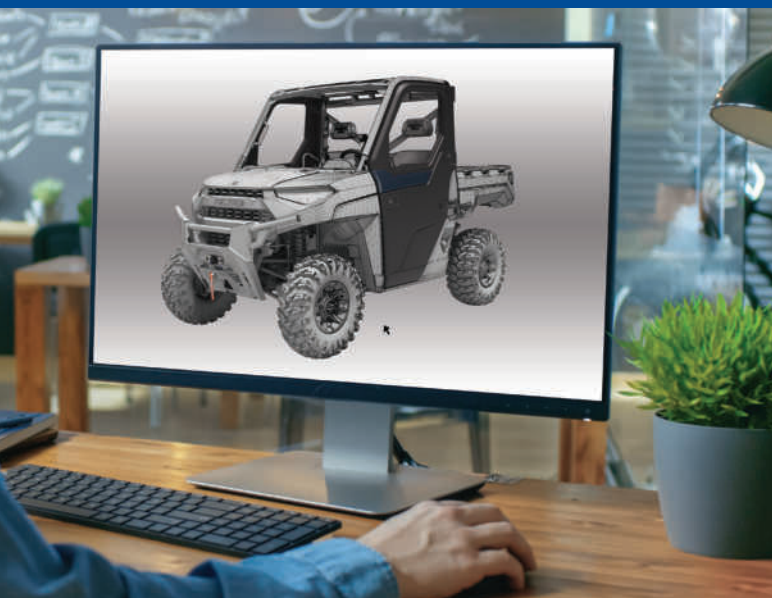

**TESTED** extensively in the field so you ride with 100% confidence.



**TRUSTED** 65 years in the business. The #1 name in Off-Road.



**RHINO-RACK®**

Rhino-Rack offers storage solutions designed specifically for Polaris RANGER. From opposite sides of the globe, some of the most capable machines in the off-road world meet a trusted outdoor adventure brand to deliver industry-exclusive, purpose-built roof racks, bed racks and accessories to help Polaris RANGER users have more fun and get more done. Designed for perfect integration and tested to off-road standards, a Rhino-Rack-equipped RANGER will help you get more storage capacity out of your machine — so you can stay prepared for whatever the day may bring.



**WE HOLD OUR PARTNERS TO THE SAME STANDARDS**



WHEELS, TIRES & LIGHTING DESIGNED WITH POLARIS TO MAXIMIZE PERFORMANCE  
P. 59 & 60



IGNITE AND FUEL YOUR PASSION FOR PRECISE QUALITY SOUND REPRODUCTION  
P. 34



PRODUCTS SO GOOD THEY REPLACE OR REPAIR THEM FOR LIFE  
P. 58



DARE TO LISTEN  
P. 78



MAKING PRODUCTS FOR AVID SPORTSMEN SINCE 1943  
P. 50



BRING IT ALL. BRING IT ON.  
P. 38





INTRODUCING THE NEW INDUSTRY-EXCLUSIVE  
RHINO-RACK® STORAGE SOLUTIONS

# BRING IT ALL. BRING IT ON.

SEE RHINO-RACK® PRODUCTS ON P. 38



RANGER XP KINETIC

# GET MORE DONE. HAVE MORE FUN.



## NEXT-LEVEL COMFORT

LEVERAGE THE FULL  
CAPABILITIES OF YOUR  
MACHINE YEAR-ROUND.

PRO SHIELD  
CAB SYSTEM



## SUPERIOR INTEGRATION

MAKE WORK EASIER WITH YOUR  
VEHICLE BUILT TO ADD ESSENTIAL  
ACCESSORIES FOR ANY JOB.

PRO PRO HEAVY DUTY SERIES  
WINCHES

GLACIER  
PLOW SYSTEM

POLARIS  
PULSE  
Electrical System



## DO MORE

TACKLE ANY JOB AND  
LEAVE NOTHING BEHIND.

LOCK & RIDE™

RHINO-RACK





# ENGINEERED FOR MORE



## HARDEST WORKING, SMOOTHEST RIDING.

RANGER is a trusted, most capable, work partner. Developed and tested along with the vehicle, Polaris Engineered Accessories are designed for seamless integration and simple installation to get more done, year-round.

## SUPERIOR INTEGRATION



P. 46

### PLUG AND PLAY ELECTRICAL

A revolution in electrical accessory integration, the Polaris PULSE Electrical System allows for a simple plug and play approach for adding power to Polaris Engineered Accessories.



RANGER 1000 / XP 1000 / XP KINETIC / DIESEL P. 30  
RANGER SP 570 P. 79  
RANGER 500 / EV / 570 P. 91

### INTEGRATED WINCH MOUNT & PRE-WIRED

Designated mounting points and pre-wired connectors ensure a perfect fit and the strongest place to attach the Polaris Engineered winch - the most dependable winch for your RANGER. With wiring built right into the vehicle, we made this the easiest RANGER winch ever to install.



P. 54

### INTEGRATED PLOW MOUNT\*

The attachment points for the Glacier Plow System are integrated right at the factory and feature an innovative drive-up and go installation process.

\*Integrated Plow Mount not included on RANGER SP 570 Non-Premium/Non-NorthStar Models



## DO MORE

### LOCK & RIDE

#### CARGO BOX VERSATILITY

Lock & Ride mounting locations allow for limitless customization to let you work the way you want.

RANGER 1000 / XP 1000 / XP KINETIC / DIESEL P. 40  
RANGER SP 570 P. 80  
RANGER 500 / EV / 570 P. 92

## BRING IT ALL. BRING IT ON.



#### STORAGE VERSATILITY

Rhino-Rack roof rack and bed rack solutions offer 40% more storage capacity so you never have to leave tools or gear behind.

RANGER 1000 / XP 1000 / XP KINETIC / DIESEL P. 38

## NEXT-LEVEL COMFORT

#### OUR BEST SEALING CAB

With the profile channels engineered into the roll cage, body plastics molded to seal and cab accessories designed to keep the elements out, the Pro Shield Cab System offers a new level of interior comfort.



RANGER 1000 / XP 1000 / XP KINETIC / DIESEL P. 18  
RANGER SP 570 P. 72

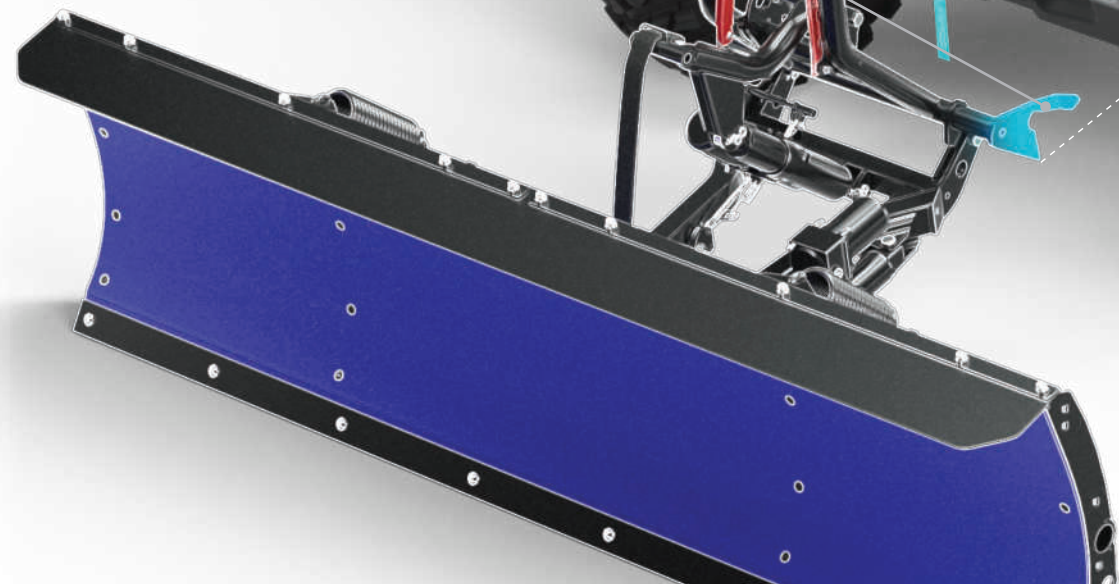



**PRO SHIELD  
CAB SYSTEM**

# NEXT-LEVEL COMFORT

Look for the Pro Shield Logo for the four components to customize your RANGER with our best sealing cab.

## BUILD YOUR CAB SYSTEM

### 1 CHOOSE YOUR ROOF

RANGER 1000 P. 18  
XP 1000  
XP KINETIC  
DIESEL  
RANGER SP 570 P. 72

### 2 CHOOSE YOUR WINDSHIELD

RANGER 1000 P. 20  
XP 1000  
XP KINETIC  
DIESEL  
RANGER SP 570 P. 74

### 3 CHOOSE YOUR REAR PANEL

RANGER 1000 P. 22  
XP 1000  
XP KINETIC  
DIESEL  
RANGER SP 570 P. 75

### 4 CHOOSE YOUR DOORS

RANGER 1000 P. 24  
XP 1000  
XP KINETIC  
DIESEL  
RANGER SP 570 P. 73

#### ULTIMATE CLARITY

Tempered safety glass, clear to see through and shatterproof.

#### COLOR MATCHED

Key color matched accent panels available.

#### PROTECTION

Inner and outer shells are made from high-quality, injection-molded plastics using a state-of-the-art process to shield from the elements and more.

#### DURABLE CONSTRUCTION

With a 2.5 cm tube steel frame, these doors can handle the rigors of the off-road.



### A FRAME DESIGNED FOR A CAB

All RANGER cab components fit perfectly to the contours of the profile tube cab frame, floor and body panels, allowing for a 360° gasket seal, seamless fit and installation providing unprecedented protection from the elements.

## INCREASED RIDER COMFORT

Add a new level of interior comfort by adding a Pro Shield Cab System – tested to military standards. Seal out dust, water, and noise by selecting a roof, windshield, rear panel, and set of doors. Extend your work day or trail ride while protecting you and your passengers from the elements.



### RAIN

Rest assured that you and your passengers will stay dry and comfortable on rainy days.



### SNOW

Keep cold wind and snow out in winter months.



### DUST

Reduce dust swirl in the cab of your RANGER for increased comfort and visibility.



# SUPERIOR INTEGRATION

**POLARIS**  
**ENGINEERED**

Right from the factory, your vehicle is built to make essential accessories like winches and plows easy to use day-in and day-out. Mounting brackets are designed into the oversized factory bumper and wiring is routed securely and properly. When it comes to RANGER, Polaris Engineered Accessories make work easier so you can get more done.

**PRO** PRO HEAVY DUTY SERIES

**HD** HEAVY DUTY SERIES



RANGER 1000 / XP 1000 / XP KINETIC / DIESEL P.30  
RANGER SP 570 P.79  
RANGER 500 / EV / 570 P.91  
RANGER 570 FULL-SIZE P.31

## PRE-WIRED CHASSIS

Dash mounted controls and wiring are installed at the factory. Mount the winch, connect the wires and trust that everything is routed safely, securely, and properly.

## NO NEED TO CUT PANELS

## FULLY INTEGRATED MOUNT & WIRING

## GLACIER<sup>®</sup> PLOW SYSTEM

P.54



## GLACIER FEATURES

- ✓ To install the plow, simply lift the mount lock handle and pull forward
- ✓ No loss of factory ground clearance when not plowing
- ✓ Don't have to crawl under the machine to release the plow blade from the vehicle
- ✓ No trimming of vehicle plastic or fascia required to mount plow or winch

Angle your blade right from your seat

**25°**

LEFT AND RIGHT



## POLARIS ENGINEERED WINCH FEATURES

✓ Tested **1,200+** pulls at max load, it works when you need it to

✓ Built to withstand **-29° C** temperatures

✓ Sealed motor & heavy duty gears  
**OPERATE FULLY SUBMERGED UNDERWATER**

✓ **MILITARY** tested & approved

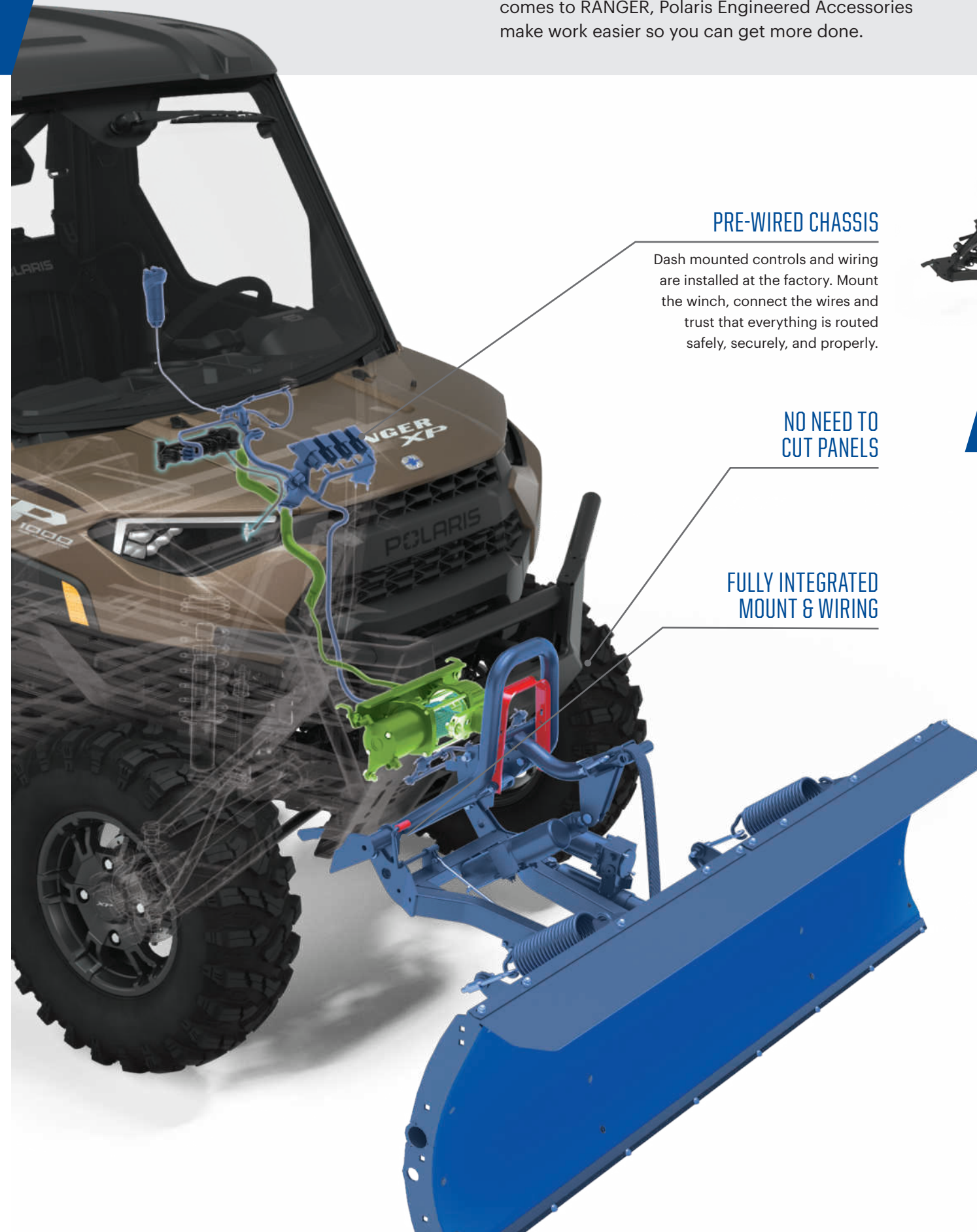



# RANGER XP KINETIC

# THE POWER TO DO MORE



Do more than ever before with the full-size electric RANGER. Unmatched horsepower and instant torque means more power than ever before to precisely pull, haul more, and get more done. The industry's strongest drivetrain delivers lower maintenance costs and more uptime to get the job done. Plus, the quiet electric powertrain enables easy conversations while riding and stealthy trips to hunting spots.



## NEW RIDE COMMAND FRONT CAMERA

- Provides additional vantage point
- Front-mounted camera to help with plowing and other tasks

» 2889662  
XP KINETIC '23



## NEW DUAL CHARGER HARNESS

- Required for installation of a 3kW On-Board Charger on XP Kinetic Premium trims

» 2890122  
XP KINETIC PREMIUM '23



## NEW IN-CAB HEATER AND DEFROST KIT



- Easily control the climate inside your cab in any season
- Helps defrost windshields and keep you warm or cool
- Three different fan speeds
- Heat and fan dash-mounted controls
- Manual vents

» 2889449  
XP KINETIC '23  
REQUIRES HIGH VOLTAGE BUSBAR 2889667 AND ADHESIVE ACCESSORY KIT 2890070



## NEW HIGH VOLTAGE BUSBAR

- Required for adding heater or other high voltage accessories such as upgraded chargers

» 2889667  
XP KINETIC '23  
REQUIRES ADHESIVE ACCESSORY KIT 2890070



## NEW ACCESSORY BUMPER HARDWARE

- Required when using a front camera as well as an upper front bumper or hood rack

» 2889659  
XP KINETIC '23



## NEW TRIPLE CHARGER HARNESS

- Required for installation of a 3kW On-Board Charger on XP Kinetic Ultimate trims

» 2890121  
XP KINETIC ULTIMATE '23



## NEW 3kW ON-BOARD CHARGER

- Provides additional 3kW charge so you can save time and get more done with your RANGER
- Increases charge rate while decreasing charge time when connected to appropriate in-home charger for more efficiency
- Maximum charge of 6kW on Premium trims and 9kW on Ultimate trims
- Upgraded 3-phase EVSE (380V power supply) required for optimal charging for Premium and Ultimate trims with 6kW or 9kW upgrade
- Pair with 3-phase EVSE (673V0001) for optimal fast charging

» 2889661  
XP KINETIC '23  
ULTIMATE TRIM: REQUIRES HIGH VOLTAGE BUSBAR 2889667, ADHESIVE ACCESSORY KIT 2890070 AND TRIPLE CHARGER HARNESS 2890121  
PREMIUM TRIM: REQUIRES HIGH VOLTAGE BUSBAR 2889667, ADHESIVE ACCESSORY KIT 2890070 AND DUAL CHARGER HARNESS 2890122

## NEW 3-PHASE EVSE

- For RANGER XP Kinetic Premium with additional 3kW charger and Ultimate trim standard and with additional 3kW charger
- It allows a faster charge for 6kW or 9kW chargers set-up compared with one-phase standard EVSE
- 3-phase (380V) power supply required

» 673V0001  
XP KINETIC '23



# MAKE IT YOURS

## WORK HARD AND GET IT DONE

with Polaris Engineered Accessories for your RANGER. Start with the ultimate in all-season performance and comfort with the best cab components in the industry. Find everything you need to outfit your RANGER for the task at hand.



RANGER 1000 / XP 1000 / XP KINETIC / DIESEL

# RANCH

2882910	Under Seat Dry Storage	P. 28	2882529	Rear Brushguard	P. 32
2882753	8-Vent Heater & Defrost System	P. 28	2882752	<b>LOCK &amp; RIDE</b> Bed Extender/Divider	P. 40
2883265	Work Beacon LED Light	P. 29	2881531	<b>LOCK &amp; RIDE</b> Tip-Down Headache Rack	P. 40
2882710	Polaris Pro HD 2,722 kg Winch with Rapid Rope Recovery	P. 31	2883121	RIGID® SR-Series 25 cm Spot LED Light	P. 58
2882531	Upper Front Brushguard	P. 32	2883148	Pro Armor Wheel & Tire Set: Dual Threat & 4202	P. 67



RANGER 1000 / XP 1000 / XP KINETIC / DIESEL

# BIG GAME

2882753	8-Vent Heater & Defrost System	P. 28	2884107	<b>LOCK &amp; RIDE</b> Kolpin Rhino Grip Pro	P. 51
2883265	Work Beacon LED Light	P. 29	2889791	Pro Armor 84 cm - Combo LED Light Bar	P. 59
2882710	Polaris Pro HD 2,722 kg Winch with Rapid Rope Recovery	P. 31	2883157	Pro Armor Wheel & Tire Set: Attack 2.0 & 5202	P. 66
2882690	Front Hood Storage Rack	P. 40			



RANGER 1000 / XP 1000 / XP KINETIC / DIESEL

# WATERFOWL

2883265	Work Beacon LED Light	P. 29	2883263	In-Cab Gun Mount	P. 51
2882711	Polaris Pro HD 2,041 kg Winch with Rapid Rope Recovery	P. 31	2889794	Pro Armor 5x5 cm Cube - LED Spot Light (x2)	P. 58
2882690	Front Hood Storage Rack	P. 40	2884271	Pro Armor Wheel & Tire Set: Mud XC & 4204	P. 66
2882177	<b>LOCK &amp; RIDE</b> CargoMax System	P. 40			



RANGER 1000 / XP 1000 / XP KINETIC / DIESEL

# CRAFTSMAN

2882711	Polaris Pro HD 2,041 kg Winch with Rapid Rope Recovery	P. 31	2881533	<b>LOCK &amp; RIDE</b> Tool Rack	P. 43
2882752	<b>LOCK &amp; RIDE</b> Bed Extender/Divider	P. 40	2889791	Pro Armor 84 cm - Combo LED Light Bar	P. 59
2882751	Cargo Bed Mat	P. 42	2882384	Wheel & Tire Set: Pro Armor Harvester & 4202	P. 66
2879354	<b>LOCK &amp; RIDE</b> Chainsaw Mount	P. 42			
2883279	<b>LOCK &amp; RIDE</b> Storage Box	P. 43			

COMPLETE LIGHTING WITH REQUIRED LIGHT BAR HARNESSES

SEE P. 58

1000 / XP 1000 / XP KINETIC / DIESEL

ROOFS

WINDSHIELDS

REAR PANELS

DOORS

CAB KITS

CAB COMFORT & CONVENIENCE

WINCHES

PROTECTION

AUDIO

STORAGE



# ROOFS

## POLY FEATURES

- Water run-off
- Polaris PULSE plug and play
- Liner ready
- Lightweight



**PREMIUM FINISH AND QUIETER RIDE**



**SEALED COVERAGE**

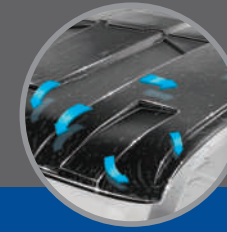

**REDUCE STANDING WATER**



**EASY AND FAST INSTALLATION**

**POLARIS ENGINEERED ADVANTAGES**

**TO SHIELD AGAINST DRIVING RAIN OR THE BLISTERING SUN,** a roof is the first must-have of the Polaris Engineered cab components. Choose from poly or steel, and get on your way with protective peace of mind.

## PREMIUM & SPORT ROOF FEATURES

SEE AUDIO OPTIONS P.34



\* PREMIUM AND SPORT FEATURES NOT AVAILABLE ON STEEL ROOFS

MULTI-FUNCTION LIGHT READY

WINDSHIELD WIPER & WASHER SYSTEM WIRING READY

POLARIS PULSE INTEGRATION

AUDIO READY

SOUND ABSORBING LINER

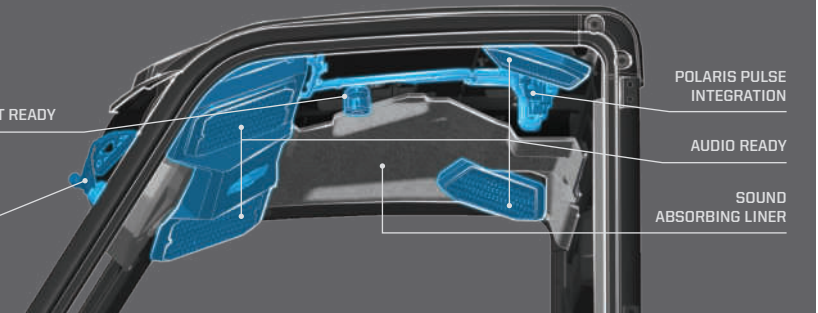

## POLY

Lightweight, durable and impact-resistant. A poly roof can take the abuse of a tough trail and still protect.

### PREMIUM ROOF - POLY

» POLARIS PURSUIT CAMO • 2882913

XP 1000 '17-23, 1000 '20-23, XP KINETIC '23, DIESEL '20-23  
INCLUDES ROOF LINER



### SPORT ROOF - POLY TOP SELLER

» BLACK • 2882911

XP 1000 '17-23, 1000 '20-23, XP KINETIC '23, DIESEL '20-23



### PREMIUM ROOF LINER

» 2882914

XP 1000 '17-23, 1000 '20-23, XP KINETIC '23, DIESEL '20-23  
WORKS WITH 2882911, 2882912, 2882913

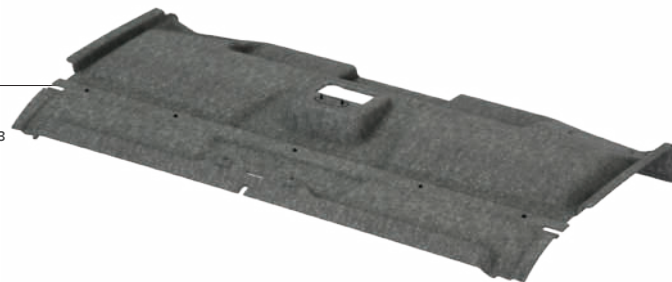

### PREMIUM ROOF CREW - POLY

» POLARIS PURSUIT CAMO • 2883277

CREW XP 1000 '19-23, CREW 1000 '20-23  
ROOF LINER INCLUDED WITH CAMO



### SPORT ROOF CREW - POLY TOP SELLER

» BLACK • 2889223

CREW XP 1000 '19-23, CREW 1000 '20-23



### PREMIUM ROOF LINER - CREW TOP SELLER

» 2883457

CREW XP 1000 '18-23, CREW 1000 '20-23



## LINERS

Get a touch of premium comfort, reduce cab noise and hide wiring. Included with Premium Poly Roofs.

## PLUG AND PLAY

ADD POWER TO PREMIUM & SPORT ROOFS P.46

1000 / XP 1000 / XP KINETIC / DIESEL

ROOFS

WINDSHIELDS

REAR PANELS

DOORS

CAB KITS

CAB COMFORT & CONVENIENCE

WINDCHES

PROTECTION

AUDIO

STORAGE



# WINDSHIELDS

## GLASS VS POLY

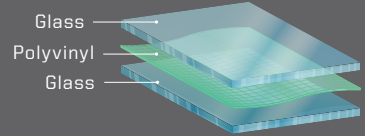

- Superior optical clarity (automotive level)
- Scratch-resistant
- Curved to fit, seals tight
- Cold weather / heavy duty
- Wiper ready

VS

- Lightweight, flexible, easy to store/remove
- Impact-resistant
- 360° seal keeps out rain and dust

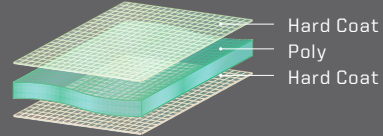

**LOCK & RIDE**  
EASY AND FAST INSTALLATION



**AIRTIGHT GASKET SEAL**



**MULTI-FUNCTION FEATURES**

**POLARIS ENGINEERED ADVANTAGES**

## HARD COAT POLY | 30x MORE SCRATCH-RESISTANT



**LOCK & RIDE**  
**FULL WINDSHIELD VENTED - HARD COAT POLY** TOP SELLER

- Frameless design for maximum visibility
  - Added vents for airflow on a hot day or defrosting on a cold day
  - Requires Wiper Install Kit, 2207624
- » **2883266**  
XP 1000 '17-23, CREW XP 1000 '18-23, CREW 1000 '20-23, 1000 '20-23, XP KINETIC '23, DIESEL '20-23



**LOCK & RIDE**  
**FULL WINDSHIELD - HARD COAT POLY** TOP SELLER

- Frameless design for maximum visibility
  - Requires Wiper Install Kit, 2207624
- » **2883300**  
XP 1000 '17-23, CREW XP 1000 '18-23, CREW 1000 '20-23, 1000 '20-23, XP KINETIC '23, DIESEL '20-23



**FLIP-DOWN WINDSHIELD - HARD COAT POLY** TOP SELLER

- Two venting options: fully sealed, flip-down or remove upper half for some protection with maximum ventilation
- » **2884139**  
XP 1000 '18-23, CREW XP 1000 '19-23, CREW 1000 '20-23, 1000 '20-23, XP KINETIC '23, DIESEL '20-23



**LOCK & RIDE**  
**FULL WINDSHIELD - POLY** TOP SELLER

- Frameless design for maximum visibility
- » **2883278**  
XP 1000 '17-23, CREW XP 1000 '18-23, CREW 1000 '20-23, 1000 '20-23, XP KINETIC '23, DIESEL '20-23



**LOCK & RIDE**  
**HALF WINDSHIELD - POLY** TOP SELLER

- Deflects air flow from straight on, but still provides air flow in the cab
- » **2883301**  
XP 1000 '17-23, CREW XP 1000 '18-23, CREW 1000 '20-23, 1000 '20-23, XP KINETIC '23, DIESEL '20-23

**ADD ALL-WEATHER VISIBILITY WINDSHIELD WIPER & WASHER SYSTEM**  
P. 28

**HARD COAT POLY WINDSHIELD WIPER & WASHER MOUNTING BRACKET**

- Required to use wiper on 2883266 or 2883300
- » **2207624**  
XP 1000 '17-23, CREW XP 1000 '18-23, CREW 1000 '20-23, 1000 '20-23, XP KINETIC '23, DIESEL '20-23



**TIP-OUT FULL WINDSHIELD - GLASS**

- Tip-out design offers three positions: open, closed and vented
  - Gas shocks assist in easy opening and closing
  - 360° gasket for reliable protection and comfort
  - Scratch-resistant automotive-style curved glass
- » **2889020**  
XP 1000 '18-23, CREW XP 1000 '19-23, CREW 1000 '20-23, 1000 '20-23, XP KINETIC '23, DIESEL '20-23



**FULL GLASS WINDSHIELD - CLEAR**

- Scratch-resistant, curved laminate safety glass
  - Protects against wind, rain and other debris
  - UV-blocking interlayer and 360° gasket seal
- » **2889021**  
XP 1000 '18-23, CREW XP 1000 '19-23, CREW 1000 '20-23, 1000 '20-23, XP KINETIC '23, DIESEL '20-23



**LOCK & RIDE**  
**FULL GLASS WINDSHIELD - CLEAR**

- Scratch-resistant, curved laminate safety glass that protects against wind, rain and other hazardous debris
  - UV-blocking interlayer and 360° gasket seal
  - Seal Kit included
- » **2889030**  
XP 1000 '17-23, CREW XP 1000 '17-23, CREW 1000 '20-23, 1000 '20-23, DIESEL '17-23



**REDUCE IN-CAB DUST SWIRL BY ADDING A REAR PANEL**  
SEE P. 22



# REAR PANELS

**GLASS** VS **POLY**

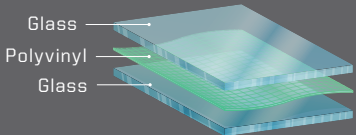

- Superior optical clarity (automotive level)
- Scratch-resistant
- Curved to fit, seals tight
- Cold weather / heavy duty
- Wiper ready (windshield only)

**POLY**

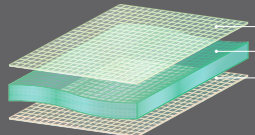

- Lightweight, flexible, easy to store/remove
- Impact-resistant
- Tight seal keeps out rain and dust



**LOCK & RIDE**  
EASY AND FAST INSTALLATION



**AIRTIGHT GASKET SEAL**



**VENTING OPTIONS**

## POLARIS ENGINEERED ADVANTAGES



### REDUCE IN-CAB DUST SWIRL BY ADDING A REAR PANEL

With a windshield and roof installed, turbulent air develops behind the cab. Add a rear panel to reduce dust intrusion from this swirl.



**HARD COAT POLY | 30x MORE SCRATCH-RESISTANT**

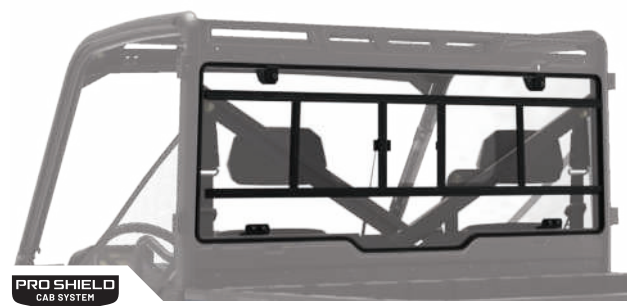

**LOCK & RIDE**  
**REAR PANEL - SLIDING GLASS**

• Sliding window provides ventilation, cab comfort and access to cargo in rear box

» **2879015**  
XP 1000 '17-23, CREW XP 1000 '18-23, CREW 1000 '20-23, 1000 '20-23, XP KINETIC '23, DIESEL '20-23

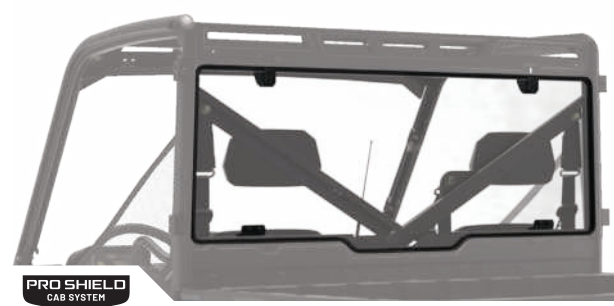

**LOCK & RIDE**  
**REAR PANEL - GLASS** **TOP SELLER**

» **2879013**  
XP 1000 '17-23, CREW XP 1000 '18-23, CREW 1000 '20-23, 1000 '20-23, XP KINETIC '23, DIESEL '20-23

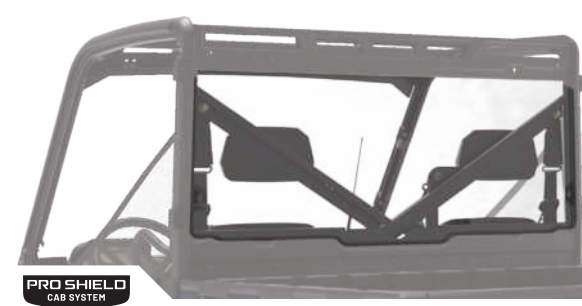

**LOCK & RIDE**  
**REAR PANEL - POLY - CLEAR** **TOP SELLER**

• Strong, thick polycarbonate provides outstanding impact and scratch resistance  
• Installs in contours of cab frame with 360° gasketing for outstanding protection, comfort, fit and finish

» **2883773**  
XP 1000 '17-23, CREW XP 1000 '18-23, CREW 1000 '20-23, 1000 '20-23, XP KINETIC '23, DIESEL '20-23



# DOORS

## THE BEST CAB

## COMPLETED

KEY FEATURES	PREMIUM POLY DOORS			POLY DOORS		CANVAS DOORS
	POWER WINDOW DOORS	MANUAL CRANK WINDOW DOORS	HALF DOORS	RANGER HUNTER DOORS	RANGER CLEARVIEW DOORS	ZIP WINDOW DOORS
PRO SHIELD CAB SYSTEM						
WINDOW TYPE / VENTILATION	GLASS / POWER	GLASS / MANUAL CRANK	NA / OPEN TOP	GLASS / HINGED	GLASS / HINGED	CLEAR POLY / ZIPPED
VISIBILITY	UPPER	UPPER	UPPER	UPPER	UPPER + LOWER	UPPER + PARTIAL LOWER
STORAGE COMPARTMENT	STANDARD	STANDARD	STANDARD			
AUDIO-READY / SPEAKER MOUNT	STANDARD, PRE-WIRED	STANDARD				
PREMIUM TPE LINER	STANDARD	STANDARD	STANDARD			
SPECIAL FEATURES	BUILT-IN FLOOR LIGHT, COLORED ACCENT PANELS AVAILABLE	COLORED ACCENT PANELS AVAILABLE	COLORED ACCENT PANELS AVAILABLE	DURABLE POLY CONSTRUCTION, POLARIS PURSUIT CAMO	DURABLE POLY CONSTRUCTION	AVAILABLE IN POLARIS PURSUIT CAMO
	<ul style="list-style-type: none"> <li>The ultimate door offering power windows, switches mounted on the door and built-in floor light.</li> </ul>	<ul style="list-style-type: none"> <li>A premium, door offering manual crank windows for airflow adjustment in the cab.</li> </ul>	<ul style="list-style-type: none"> <li>Provides lower protection from the off-road with an open-air experience.</li> </ul>	<ul style="list-style-type: none"> <li>Tough clear poly shell extends from the bottom of the door until it meets the upper-hinged glass window.</li> <li>Premium Polaris Pursuit Camo pattern offers extensive camo coverage.</li> </ul>	<ul style="list-style-type: none"> <li>Deliver nearly uninterrupted visibility and maximum ambient lighting inside the cab.</li> <li>Tough clear poly shell extends from the bottom of the door until it meets the upper-hinged glass window.</li> </ul>	<ul style="list-style-type: none"> <li>Lightweight, durable protection with adjustable zipper ventilation and see-through bottom panel.</li> </ul>

Front and Rear Doors are required to complete a cab on CREW RANGER models.

Premium Doors come with Gloss Black Exterior Door Accent Panels, images shown with optional Exterior Door Accent Panels.

<b>FRONT DOORS (SET OF 2)</b> XP 1000 '18-23, CREW XP 1000 '19-23, CREW 1000 '20-23, 1000 '20-23, XP KINETIC '23, DIESEL '20-23	 <b>NEW TOP SELLER</b> Power Window Doors - Poly - Black 2889813	 <b>NEW TOP SELLER</b> Manual Crank Window Doors - Poly - Black 2889811	 <b>NEW</b> Half Doors - Poly 2889814	 RANGER Hunter Doors - Polaris Pursuit Camo 2883229	 RANGER ClearView Doors 2882901	 <b>TOP SELLER</b> Zip Window Doors - Canvas - Black 2882902	 Zip Window Doors - Canvas - Polaris Pursuit Camo 2882903
	<b>REAR DOORS (SET OF 2)</b> CREW XP 1000 '19-23, CREW 1000 '20-23	 <b>NEW TOP SELLER</b> Manual Crank Window Doors - Rear - Poly 2889812	 Half Doors - Rear - Poly 2883438			 RANGER ClearView Doors - Rear 2883632	 Zip Window Doors - Rear - Canvas - Black 2883634

### EXTERIOR DOOR ACCENT PANELS

• Replace stock gloss black accent panels

• Painted plastic and clear-coated for UV protection

• Install easily with a single screw

• Comes as a pair

FRONT REAR	 <b>NEW</b> Super Graphite 2882870-509 2883829-509	 <b>NEW</b> Azure Crystal 2882870-809 2883829-809	 <b>NEW</b> Bronson Rock 2882870-755 2883829-755	 <b>NEW</b> Springfield Blue 2882870-640 2883829-640	 <b>NEW</b> White Lightening 2882870-599 2883829-599	 Polaris Pursuit Camo 2882870-587 2883829-587	 Pearl White 2882870-566
FRONT REAR	 Solar Red 2883499-342	 Black Pearl 2882870-666	 Matte Sunset Red 2882870-669	 Matte Sagebrush Green 2882870-685 2883829-685	 Sunset Red Metallic 2882870-520 2883829-520	 Matte Navy 2882870-726 2883829-726	 Burgundy Metallic 2882870-629
FRONT REAR	 Steel Blue 2882870-765 2883829-765	 Ghost White Metallic 2882870-774 2883829-774	 Polaris Blue 2882870-795 2883829-795	 Stealth Gray 2882870-804 2883829-804	 Onyx Black 2882870-866	 Icy White Pearl 2882870-911	



REQUIRED POLARIS PULSE INSTALLATION ITEMS

GET SUPERIOR PERFORMANCE AND OUR BEST SEAL with the Pro Shield Cab System door line

360° GASKET SEAL

EASY TO CLEAN TPE LINER

BUILT-IN STORAGE

AUDIO-READY

VENTILATION OPTIONS



# CAB KITS

PICK YOUR OWN PACKAGE!

## FULL CAB PREMIUM

28K0001

2882912	Premium Roof - Poly - Black	P. 18
2889020	Tip-Out Full Windshield - Glass	P. 20
2879013	Rear Panel - Glass	P. 22
2889811	Manual Crank Window Doors - Poly - Black	P. 24
2883974	Windshield Wiper & Washer System	P. 28

XP 1000 '18-'23, 1000 '20-'23, XP KINETIC '23, DIESEL '20-'23



## FULL CAB NORDIC

28K0006

2882912	Premium Roof - Poly - Black	P. 18
2889021	Full Glass Windshield - Clear	P. 20
2879013	Rear Panel - Glass	P. 22
2889811	Manual Crank Window Doors - Poly - Black	P. 24
2883974	Windshield Wiper & Washer System	P. 28

XP 1000 '18-'23, 1000 '20-'23, XP KINETIC '23, DIESEL '20-'23



## FULL CAB

28K0002

2882912	Premium Roof - Poly - Black	P. 18
2889021	Full Glass Windshield - Clear	P. 20
2879013	Rear Panel - Glass	P. 22
2882901	ClearView Doors	P. 25
2883974	Windshield Wiper & Washer System	P. 28

XP 1000 '18-'23, 1000 '20-'23, XP KINETIC '23, DIESEL '20-'23



## HALF CAB

28K0003

2882912	Premium Roof - Poly - Black	P. 18
2889021	Full Glass Windshield - Clear	P. 20
2879013	Rear Panel - Glass	P. 22
2883974	Windshield Wiper & Washer System	P. 28

XP 1000 '18-'23, 1000 '20-'23, XP KINETIC '23, DIESEL '20-'23



**ADD TO YOUR CAB COMFORT**  
WITH THE HEATER SYSTEM

### HEATER SYSTEM

P. 28

- » **TOP SELLER** 2882753 **XP 1000 ONLY**  
XP 1000 '18-'23
- » **TOP SELLER** 2884066 **1000 ONLY**  
1000 '20-'23
- » **TOP SELLER** 2884212  
DIESEL '20-'23
- » 2889449  
XP KINETIC '23  
REQUIRES HIGH VOLTAGE BUSBAR 2889667 AND 2890070





# CAB COMFORT & CONVENIENCE



## POLARIS RANGER XP FULL-SIZE SEATSAVER - SPLIT BENCH SEAT XP 1000 ONLY

Covers the back and bottom of seat

- » POLARIS PURSUIT CAMO • 2883244-587
- » CARHARTT BROWN • 2883244-218
- » CARHARTT GRAVEL • 2883244-458

XP 1000 '18-21, CREW XP 1000 '19-21, XP KINETIC '23, DIESEL '20-23  
CREW: FITS FRONT SEATS ONLY  
NO REAR SEAT COVERS AVAILABLE

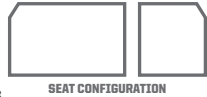

## 8-VENT HEATER & DEFROST SYSTEM



- Easily control the climate inside your cab in any season
- Helps defrost windshields and keeps you warm or cool
- Heat and fan dash-mounted controls
- Manual vents

» **TOP SELLER** 2882753 XP 1000 ONLY

XP 1000 '18-23, CREW XP 1000 '19-23

» **TOP SELLER** 2884066 1000 ONLY

CREW 1000 '20-23, 1000 '20-23

NEED ADAPTER: 2884163 ON CREW 1000

» 2884212

DIESEL '20-23

» CREW HEATER ADAPTER KIT 1000 ONLY

2884163

CREW 1000 '20-23



## SIDE VIEW MIRRORS

- Mounts on any RANGER vehicle that is equipped with doors
- Fully adjustable to accommodate riders of all sizes and can fold in to prevent being struck

» DOOR MOUNTED (shown) • 2889241

» ROPS-MOUNTED • 2889243

WINTER AVAILABILITY

» DOOR MOUNT ADAPTOR • 2209164

ONLY NEEDED TO MOUNT 2889243 ON DOORS

XP 1000 '18-23, CREW XP 1000 '19-23, CREW 1000 '20-23, 1000 '20-23, XP KINETIC '23, DIESEL '20-23



## UNDER SEAT DRY STORAGE XP 1000 ONLY

» 2882910

XP 1000 '18-23, CREW XP 1000 '19-23, XP KINETIC '23, DIESEL '20-23  
WILL NOT WORK WITH SUBWOOFER 2882890 & 2884233



## WINDSHIELD WIPER & WASHER SYSTEM



» 2883974  
XP 1000 '18-23, CREW XP 1000 '19-23, CREW 1000 '20-23, 1000 '20-23, XP KINETIC '23, DIESEL '20-23  
REQUIRES MOUNT KIT 2207624 FOR POLY WINDSHIELDS

## HARD COAT POLY WINDSHIELD WIPER & WASHER SYSTEM MOUNTING BRACKET

» 2207624

XP 1000 '17-23, CREW XP 1000 '18-23, CREW 1000 '20-23, 1000 '20-23, XP KINETIC '23, DIESEL '20-23  
REQUIRED TO USE WIPER ON 2883266 OR 2883300

## LARGE REAR VIEW MIRROR TOP SELLER

» 2879969

XP 1000 '17-23, CREW XP 1000 '18-23, CREW 1000 '20-23, 1000 '20-23, XP KINETIC '23, DIESEL '20-23



## FLOOR MATS - 3 SEAT

» 2882780 XP 1000 ONLY

XP 1000 '18-23, CREW XP 1000 '19-23, XP KINETIC '23, DIESEL '20-23  
CREW: FITS FRONT SEATS ONLY

» 2884247 1000 ONLY

CREW 1000 '20-23, 1000 '20-23  
CREW: FITS FRONT SEATS ONLY

## NOISE REDUCTION SYSTEM

» 2883489

XP 1000 '18-23, CREW XP 1000 '19-23, 1000 '20-23, CREW 1000 '20-23, XP KINETIC '23, DIESEL '20-23  
DESIGNED TO ATTACH TO THE REAR CLOSURE PANEL OF YOUR RANGER CAB, THE SOUND ABSORBING MATERIAL REDUCES UNWANTED NOISE FOR A QUIETER CAB

## WIDE ANGLE REAR VIEW MIRROR

- Large 6.4 x 35.6 cm adjustable convex mirrored surface gives you a full-spectrum view

» 2881439

XP 1000 '17-23, CREW XP 1000 '18-23, CREW 1000 '20-23, 1000 '20-23, XP KINETIC '23, DIESEL '20-23



## REMOTE GARAGE DOOR OPENER BY HOMELINK

- Control up to two garage doors

» 2882892

XP 1000 '18-23, CREW XP 1000 '19-23, CREW 1000 '20-23, 1000 '20-23, XP KINETIC '23, DIESEL '20-23



## IN-CAB HEATER AND DEFROST KIT



- Easily control the climate inside your cab in any season
- Helps defrost windshields and keep you warm or cool
- Three different fan speeds
- Heat and fan dash-mounted controls
- Manual vents

» 2889449

XP KINETIC '23  
REQUIRES HIGH VOLTAGE BUSBAR 2889667 AND ADHESIVE ACCESSORY KIT 2890070, SOLD SEPARATELY



## NEW 12V CARGO BED POWER KIT\*

- Additional power for your tools or accessories
- Requires 12V In-Bed Power Harness Extension (sold separately)

» 2889673

XP 1000 '18-23, CREW XP 1000 '18-23, 1000 '20-23, CREW 1000 '20-23, DIESEL '20-23  
REQUIRES 12V IN-BED POWER HARNESS EXTENSION 2890068, SOLD SEPARATELY



## NEW 12V IN-BED POWER HARNESS EXTENSION\*

- Required for Installation of 12V Cargo Bed Power Kit (2889673)

» 2890068

CREW XP 1000 '18-23, CREW 1000 '20-23, DIESEL '20-23



## NEW UPPER SWITCH PANEL\*

- Add up to 4 additional electrical accessory switches
- Convenient roof-mounted overhead panel
- Includes mounting hardware

» 2889674

XP 1000 '18-23, CREW XP 1000 '18-23, 1000 '20-23, CREW 1000 '20-23, DIESEL '20-23  
REQUIRES UPPER SWITCH PANEL LIGHTBAR HARNESS 2889675, SOLD SEPARATELY



## NEW UPPER SWITCH PANEL LIGHTBAR HARNESS\*

- Required for Upper Switch Panel installation

» 2889675

» EXTENSION • 2890067  
XP 1000 '18-23, CREW XP 1000 '18-23, 1000 '20-23, CREW 1000 '20-23, DIESEL '20-23



With Polaris PULSE it's easy to add all your electrical accessories.  
SEE P. 46 TO LEARN MORE

## WORK BEACON LED LIGHT

- 15.2 m of illumination 360° around your vehicle
- Ideal for plowing, hunting and nighttime utility work
- Break-away construction protects the light in areas with tight clearance
- Mounted to the vehicle on the rear of the ROPS
- Easily hinge the light up during use and hinge it down when in transit
- Add LED Headlights for more light

» 2883265

XP 1000 '18-23, CREW XP 1000 '19-23, CREW 1000 '20-23, 1000 '20-23, XP KINETIC '23, DIESEL '20-23  
REQUIRES LIGHT BAR HARNESS/EXTENSION 2883230 AND 2883854, SOLD SEPARATELY

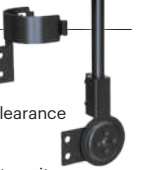

## NEW REAR LED WORK LIGHT

- Mounts to the back of your cab to fully illuminate the cargo box and surrounding area

- Includes necessary mounting hardware

- Requires a harness

» 2889672

XP 1000 '18-23, CREW XP 1000 '18-23, 1000 '20-23, CREW 1000 '20-23, DIESEL '20-23



## MULTI-FUNCTION CAB LIGHT



- LED dome light provides white, red, green and blue lighting options
- Battery-operated. Recharges when the vehicle is on
- Can be removed to use as a flashlight in and around your vehicle

- Red light is great for reading maps
- Green light is perfect for navigating in the dark
- Blue light is ideal for night riding

» 2882871

XP 1000 '18-23, CREW XP 1000 '19-23, CREW 1000 '20-23, 1000 '20-23, XP KINETIC '23, DIESEL '20-23  
REQUIRES ROOF PULSE 2882904, SOLD SEPARATELY

## LED HEADLIGHTS DIESEL ONLY

- LED Headlights offer improved brightness and illumination vs stock halogen lights
- Designed with styling specific to Ranger DIESEL

» 2889576

DIESEL '20-23



## REVERSE WARNING ALERT

» 2883246

XP 1000 '18-23, CREW XP 1000 '19-23, CREW 1000 '20-23, 1000 '20-23, XP KINETIC '23, DIESEL '20-23  
AUTOMATICALLY ACTIVATED WHENEVER THE VEHICLE IS PUT IN REVERSE

## HORN TOP SELLER



» 2882764

XP 1000 '18-23, CREW XP 1000 '19-23, CREW 1000 '20-23, 1000 '20-23, XP KINETIC '23, DIESEL '20-23

\*Check with your local dealer for availability.

1000 / XP 1000 / XP KINETIC / DIESEL

ROOFS

WINDSHIELDS

REAR PANELS

DOORS

CAB KITS

CAB COMFORT & CONVENIENCE

WINDSHIELDS

PROTECTION

AUDIO

STORAGE



# WINCHES

## DEPENDABLE. TOUGH. BUILT FOR THE OFF-ROAD.

A Polaris Engineered winch is designed to help you get the job done right, get you on your way faster and prepare you for the unexpected.

### WHY POLARIS?

Polaris off-road vehicles are engineered with designated mounting points and wiring for seamless install of Polaris Engineered winches.



TESTED **1,200+** PULLS AT MAX LOAD



BUILT TO WITHSTAND **-29° C** TEMPERATURES



OPERATES **FULLY SUBMERGED**



**MILITARY** TESTED & APPROVED

## UPGRADE YOUR CONTROLS

### DASH WINCH SWITCH KIT

- Allows user to add a dash switch as an additional means to control winch
- Can be used with all winches and are compatible with other control methods (wireless/wired)

» 2889050

XP 1000 '18-23, CREW XP 1000 '19-23, CREW 1000 '20-23, 1000 '20-23, XP KINETIC '23, DIESEL '20-23

TOP SELLER

### POWER CONTROLLER



- Control winch/plow hydraulics from shift knob

» 2889247

XP 1000 '18-23, CREW XP 1000 '19-23, CREW 1000 '20-23, 1000 '20-23, XP KINETIC '23, DIESEL '20-23

REQUIRES WINCH ADAPTER 2884159 WHEN USING A WINCH FOR LIFTING DEVICE

### WIRED REMOTE CONTROL

- Handle and socket both required

» REMOTE HANDLE • 4013466

» SOCKET • 4017102

WORKS WITH ALL MODELS

## REPLACEMENT PARTS

### SYNTHETIC ROPE

- 2,722 kg » 2879188
- 2,041 kg » 2879187



ADD A PLOW  
P. 54

## FEATURES & BENEFITS

### ALL POLARIS ENGINEERED WINCHES COME WITH:

- ✓ INTEGRATED WIRING, MOUNT, PREASSEMBLED
- ✓ HOOK WITH STRAP
- ✓ CUT STEEL GEARS & SEALED DRIVETRAIN
- ✓ SEALED PERMANENT MAGNET MOTOR



Retrieve cable 5x as fast as standard mode on other Polaris winches. Get back to riding or complete your task quicker.

1. Set winch dial to N (Neutral) to manually pull the rope out and secure the hook to your anchor point
2. Set winch dial to L (Low) for maximum pulling power while winching your load
3. Set winch dial to H (High) for retrieving the rope 5x faster with Rapid Rope Recovery

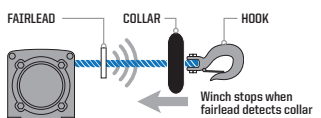

Auto Stop technology protects and extends the life of your winch by automatically stopping the winch at the end of pull to prevent over-spooling. While plowing, it prevents the plow frame from bending by stopping the winch once the plow has been lifted.



With its lightweight, yet extremely strong, design and superior flexibility, this 50 ft long synthetic rope is easy to handle and can stand up to any tough job.



This convenient remote operates your Polaris winch wirelessly from within 50 ft of the vehicle. Operate your winch safely outside your vehicle while on the job site or trails.

MODEL	2,722 kg	2,041 kg	2,041 kg
<b>XP 1000</b> '18-23 <b>CREW XP 1000</b> '19-23 <b>1000</b> '20-23 <b>CREW 1000</b> '20-23 <b>XP KINETIC</b> '23 <b>DIESEL</b> '20-23 NON EPS RANGER 1000 REQUIRES FRONT BUMPER	TOP SELLER <b>2882710</b>	TOP SELLER <b>2882711</b>	TOP SELLER <b>2882714</b>

## PRO PRO HEAVY DUTY SERIES

### TOP-OF-THE-LINE FEATURES

BEST FOR PLOWING, HEAVY-DUTY OUTDOOR CHORES & TRAIL RIDING



## PRO PRO HEAVY DUTY SERIES

## HD HEAVY DUTY SERIES

### BUILT FOR THE OFF-ROAD

BEST FOR THE CASUAL OFF-ROAD RIDER



## HD HEAVY DUTY SERIES

1000 / XP 1000 / XP KINETIC / DIESEL  
ROOFS  
WINDSHIELDS  
REAR PANELS  
DOORS  
CAB KITS  
CAB COMFORT & CONVENIENCE  
WINCHES  
PROTECTION  
AUDIO  
STORAGE



# PROTECTION

PERFECT FOR: **INCREASED PROTECTION AROUND LIGHTING AND FENDERS**

## STANDARD BRUSHGUARDS



FRONT

## HD BRUSHGUARDS

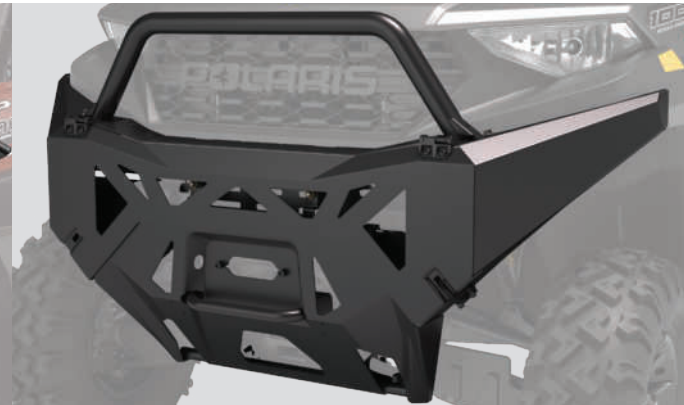

FRONT

4.4 cm DIAMETER STEEL TUBE CONSTRUCTION



REAR



REAR

To use Front Bumper with RIDE COMMAND and Front Camera, RIDE COMMAND Bumper Adapter (2207941) is required

- » **TOP SELLER FRONT • 2882531**  
XP 1000 '18-23, CREW XP 1000 '19-23, CREW 1000 '20-23, 1000 '20-23, XP KINETIC '23, DIESEL '20-23  
FRONT BRUSHGUARD DOES NOT FIT HIGH LIFTER MODELS  
1000 NON-EPS VEHICLES REQUIRE FRONT BUMPER: 2884123
- » **TOP SELLER REAR • 2882529**  
XP 1000 '18-23, CREW XP 1000 '19-23, CREW 1000 '20-23, 1000 '20-23, XP KINETIC '23, DIESEL '20-23  
FRONT BRUSHGUARD DOES NOT FIT HIGH LIFTER MODELS  
1000 NON-EPS VEHICLES REQUIRE FRONT BUMPER: 2884123
- » **RIDE COMMAND BUMPER ADAPTER • 2207941**  
FOR USE ON VEHICLES WITH RIDE COMMAND AND FRONT CAMERA

Increased protection over stock bumper with integrated mounting locations for accessories and lights (sold separately) with a durable matte black finish

- Easy installation with included mounting hardware
- Additional 36" storage area for recovery equipment

- » **FRONT • 2885105**  
XP 1000 '18-23, CREW XP 1000 '19-23, CREW 1000 '20-23, 1000 '20-23, XP KINETIC '23, DIESEL '20-23  
FRONT BRUSHGUARD DOES NOT FIT HIGH LIFTER MODELS  
REAR: RECOMMENDED WITH RIGID OR PRO ARMOR POD LIGHTS FOR UPGRADED LIGHTING
- » **REAR • 2884217**  
XP 1000 '18-23, CREW XP 1000 '19-23, CREW 1000 '20-23, 1000 '20-23, XP KINETIC '23, DIESEL '20-23

## HIGH-MOUNTED FRONT BRUSHGUARD



FRONT

## FRONT BRUSHGUARD 1000 ONLY

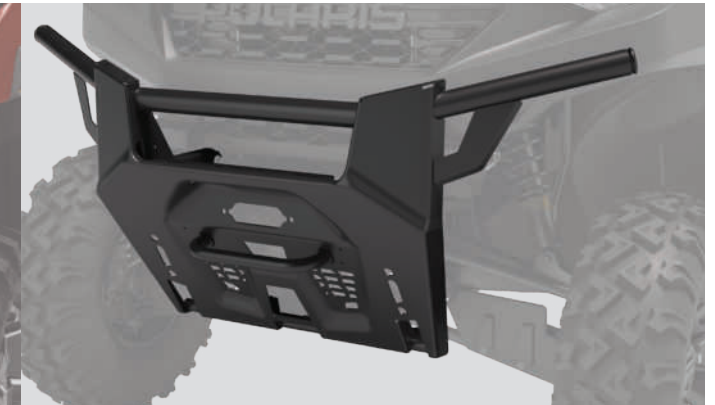

FRONT

- Increased protection over stock bumper
- Offers a higher winch mounting position which allows for easier access when used in deep mud
- Not compatible with Polaris Plow Systems

- » **2889271**  
XP 1000 '18-23, CREW XP 1000 '19-23, CREW 1000 '20-23, 1000 '20-23, XP KINETIC '23, DIESEL '20-23

- Increased protection over stock bumper
- Sturdy stamped steel and tube construction
- Integrated mounting positions for plow and winch accessories

- » **2889330**  
CREW 1000 '20-23, 1000 '20-23, DIESEL '20-23  
REQUIRED TO INSTALL WINCH/PLOW ON NON EPS RANGER 1000

## HIGH-MOUNTED HD 2,041 KG WINCH

- Provides outstanding performance and versatile pulling power
- The elevated mounting position allows for easier access when used in deep mud

- » **2889272**  
XP 1000 '18-23, CREW XP 1000 '19-23, CREW 1000 '20-21, 1000 '20-23, XP KINETIC '23, DIESEL '20-23



## ACCESSORY BUMPER HARDWARE

- Required when using a front camera as well as an upper front bumper or hood rack

- » **2889659**  
XP KINETIC '23



## ROCK GUARDS



### ROCK GUARD WITH STEP

- Reliable, hard-working protection for edges of vehicle
- Integrated step with boot scraper helps keep interior clean
- Mounts directly to the frame, instead of underneath, for maximum ground clearance
- Steel construction with black e-coat and durable black powder-coated finish



- » **TOP SELLER 3-SEAT • 2882530**  
XP 1000 '18-23, 1000 '20-23, XP KINETIC '23, DIESEL '20-23
- » **CREW • 2883398**  
CREW XP 1000 '19-23, CREW 1000 '20-23

## A-ARMS



### HIGH CLEARANCE A-ARMS

- Valuable, reliable protection for vital front suspension components exposed to the rigors of off-road environments
- Strong, durable, lightweight polyethylene construction withstands off-road impacts to protect the A-Arms

- » **FRONT • 2889269**  
XP 1000 '18-23, CREW XP 1000 '19-23, CREW 1000 '20-23, 1000 '20-23, XP KINETIC '23
- » **REAR • 2889270**  
XP 1000 '18-23, CREW XP 1000 '19-23, CREW 1000 '20-23, 1000 '20-23, XP KINETIC '23

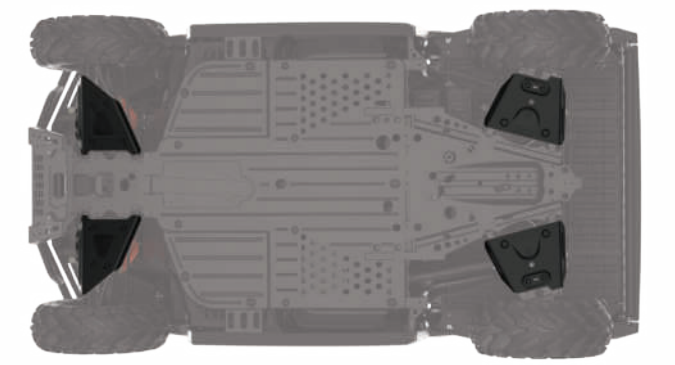

### HMW A-ARM GUARDS

- Strong, .64 cm thick, durable, lightweight HMW (high molecular weight) polyethylene construction helps protect against off-road impacts
- Molded specifically for the RANGER XP 1000 & 1000 front suspension for a sure fit and low-profile presence
- Easy bolt-on design with mounting hardware included

- » **FRONT • 2882784**  
XP 1000 '18-20, CREW XP 1000 '19-20, CREW 1000 '20-23, 1000 '20-23, XP KINETIC '23, DIESEL '20-23  
WILL NOT FIT ARCHED A-ARM MODELS
- » **REAR • 2882787**  
XP 1000 '18-23, CREW XP 1000 '19-23, CREW 1000 '20-23, 1000 '20-23, XP KINETIC '23, DIESEL '20-23  
WILL NOT FIT ARCHED A-ARM MODELS



# AUDIO

BUILD YOUR AUDIO SYSTEM

## OFF-ROAD GRADE AUDIO

MB Quart, combined with Polaris, engineers Off-Road Grade Audio equipment that's proven to deliver the loudest, crispest sound in the harshest conditions. Rain, snow, mud, heat, cold, dust—**ANY PLACE YOUR RANGER EXCELS, SO WILL YOUR AUDIO.**

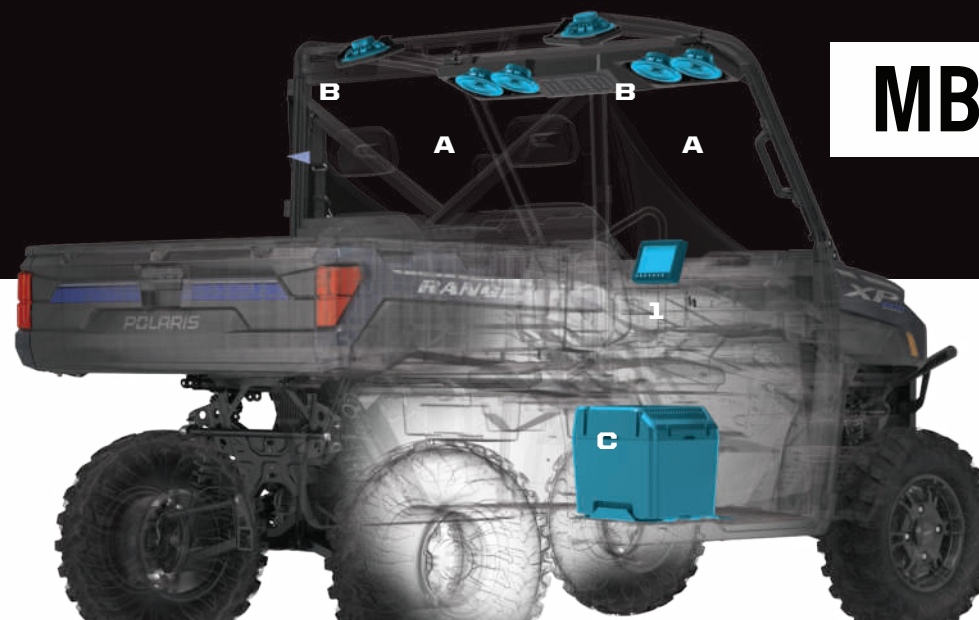

### BUILD YOUR SOUND WITH RIDE COMMAND

<p><b>STEP 1</b></p> <p><b>ADD HEAD UNIT</b></p> <p><b>7" DISPLAY POWERED BY RIDE COMMAND*</b></p> <p>2884072</p> <p>SEE P. 45 FOR MORE INFORMATION</p> <p><small>*Due to ongoing supply chain issues, there may be delayed or limited availability of this product as an accessory add-on.</small></p>	<p><b>STEP 2</b></p> <p><b>ADD MOUNT</b></p> <p>2889309</p> <p>XP 1000 '22-23, CREW XP 1000 '22-23, CREW 1000 '22-23, 1000 '22-23, XP KINETIC '23</p> <p>FOR INTERNATIONAL MODELS</p>
---	---

### STEP 3 UPGRADE AUDIO BY ADDING VISOR OR DASH AUDIO

**OPTION 1 VISOR AUDIO**

<p><b>A. OVERHEAD VISOR SPEAKERS</b></p> <p>2882891</p> <p><b>HARNES REQUIRED</b></p> <p>TOP SELLER 2882904</p> <p>CREW MODELS REQUIRE ADDITIONAL 2883231</p>	+	<p><b>B. REAR OVERHEAD SPEAKERS</b></p> <p>TOP SELLER 2882876</p> <p>XP 1000 '18-23, CREW XP 1000 '19-23, CREW 1000 '20-23, 1000 '20-23, XP KINETIC '23</p>	+	<p><b>C. 25.4 cm MAXBOOST SUBWOOFER</b></p> <p>2884233</p> <p>XP 1000 '18-23, CREW XP 1000 '19-23, XP KINETIC '23 WITH 900 WATT STATOR</p>
---	---	---	---	--

**OPTION 2 DASH AUDIO**

<p><b>AUDIO DASH SPEAKERS</b></p> <p>TOP SELLER 2883956</p> <p>XP 1000 '19-23, CREW XP 1000 '19-23, CREW 1000 '20-23, 1000 '20-23, XP KINETIC '23</p>	+	<p><b>B. REAR OVERHEAD SPEAKERS</b></p> <p>TOP SELLER 2882876</p> <p>XP 1000 '18-23, CREW XP 1000 '19-23, CREW 1000 '20-23, 1000 '20-23, XP KINETIC '23</p>	+	<p><b>C. 25.4 cm MAXBOOST SUBWOOFER</b></p> <p>2884233</p> <p>XP 1000 '18-23, CREW XP 1000 '19-23, XP KINETIC '23 RANGER MODELS WITH RIDE COMMAND PACKAGE REQUIRE 2883232 ADAPTER HARNES</p>
---	---	---	---	--

AUDIO DASH SPEAKERS INCLUDE BUILT-IN FOUR CHANNEL AMPLIFIER (40-WATTS) AND TWO OFF-ROAD GRADE 13.3 cm SPEAKERS

DOWNLOAD THE RIDE COMMAND MOBILE APP



1000 / XP 1000 / XP KINETIC / DIESEL

ROOFS

WINDSHIELDS

REAR PANELS

DOORS

CAB KITS

CAB COMFORT & CONVENIENCE

WINCHES

PROTECTION

AUDIO

STORAGE



# AUDIO

## BUILD YOUR AUDIO SYSTEM

MBQUARTI®

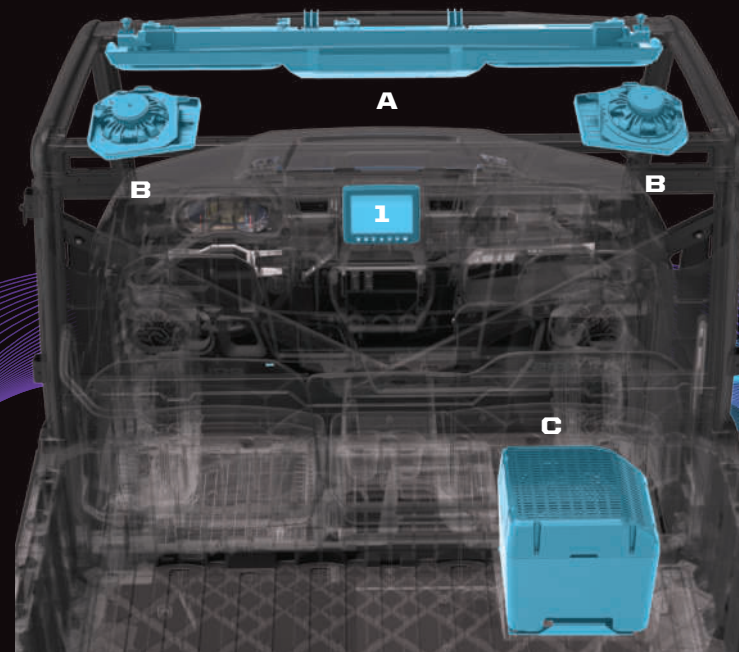

### 1 CHOOSE A HEAD UNIT Control all aspects of your sound system. Choose what to listen to and how loud.



#### 160 WATT, WATERPROOF AM/FM BLUETOOTH AUDIO SYSTEM TOP SELLER



- All-in-one solution for giving your vehicle a performance-ready sound system
- USB input, Bluetooth 4.0 compatible, Apple Control, AM/FM tuner\*
- Built-in four channel amplifier (40-watts x 4)
- Two off-road grade 13.3 cm speakers with titanium dome tweeters and polypropylene cones

» 2882750  
XP 1000 '18-'23, CREW XP 1000 '19-'23, CREW 1000 '20-'23, 1000 '20-'23, XP KINETIC '23

USE AS IS OR ADD ADDITIONAL SPEAKERS



#### 300 WATT AM/FM, BLUETOOTH AUDIO VISOR WITH FOUR 16.5 cm WATERPROOF SPEAKERS TOP SELLER



- One-step solution for off-road audio
- USB input, Bluetooth 4.0 compatible, Apple Control, AM/FM tuner\*
- 300-Watt four channel amplifier (75 watts x 4)
- Four 16.5 cm coaxial speakers with titanium dome tweeters and polypropylene cones
- Audio outputs to drive additional speakers
- Four Accessory knocks out

» 2882888  
XP 1000 '18-'23, CREW XP 1000 '19-'23, CREW 1000 '20-'23, 1000 '20-'23, XP KINETIC '23  
NOT COMPATIBLE WITH 7" DISPLAY POWERED BY RIDE COMMAND

COMES WITH OVERHEAD VISOR SPEAKERS (AT RIGHT) USE AS IS OR ADD ADDITIONAL SPEAKERS

### 2 ADD SPEAKERS - MIX AND MATCH

Your RANGER is ready for work, but is it ready to entertain? From a simple two-speaker setup to a complete system - add speakers to BUILD IT YOUR WAY.



#### A VISOR SPEAKERS

#### STANDARD WITH VISOR STEREO

#### 300 WATT OVERHEAD AUDIO VISOR SPEAKERS

- Built-in 300-Watt amplifier (75-watt x 4 channels)
- Four 16.5 cm speakers located in the overhead
- Waterproof system for reliable power and sound quality

» 2882891  
XP 1000 '18-'23, CREW XP 1000 '19-'23, CREW 1000 '20-'23, 1000 '20-'23, XP KINETIC '23



#### B OVERHEAD SPEAKERS

#### REAR OVERHEAD SPEAKERS TOP SELLER

- Two 16.5 cm rear roof mounted speakers with titanium dome tweeters and polypropylene cones
- Easy install
- Waterproof system for reliable power and sound quality

» 2882876  
XP 1000 '18-'23, CREW XP 1000 '19-'23, CREW 1000 '20-'23, 1000 '20-'23, XP KINETIC '23



#### C SUBWOOFER

#### MAX BOOST 25.4 CM 250 WATT SUBWOOFER XP 1000 ONLY

- Built-in 250-watt amplifier powering 25.4 cm waterproof subwoofer
- Fits RANGER XP 1000 with flip-up passenger seat

» 2882890  
XP 1000 '18-'23, CREW XP 1000 '19-'23, XP KINETIC '23  
NOT COMPATIBLE WITH 7" DISPLAY POWERED BY RIDE COMMAND, WILL NOT FIT WITH 2882910 STORAGE INSTALLED

### 3 MAKE IT WORK

#### VISOR STEREO HEAD UNIT

#### VISOR SPEAKERS

#### POLARIS PULSE ROOF 6

- Required with Visor Stereo (2882888)
- Required to add Visor Speakers (2882891)

» TOP SELLER 2882904  
XP 1000 '18-'23, CREW XP 1000 '19-'23, CREW 1000 '20-'23, 1000 '20-'23, XP KINETIC '23

#### CREW MODELS

#### CREW EXTENSION

- Required for all Crew models where Polaris PULSE Roof 6 Harness (2882904) is required

» 2883231  
CREW XP 1000 '19-'23, CREW 1000 '20-'23

#### GEOFENCING KIT 1000 ONLY

- Keep vehicle operators safe by quickly setting and controlling ride boundaries such as speed limits within and outside the geofenced area

- Ensure operators are riding at the appropriate speed for their experience and terrain by setting a max speed from your RIDE COMMAND app

- Activate passcode protection and to have full control of who and when the vehicle is being operated

» 2884779  
CREW 1000 '20-'23, 1000 '20-'23  
NOT AVAILABLE IN EUROPE

\* The FM Frequency range is from 88 to 108 and only on the odds (i.e. 88.1, 88.3, etc.).

1000 / XP 1000 / XP KINETIC / DIESEL

ROOFS

WINDSHIELDS

REAR PANELS

DOORS

CAB KITS

CAB COMFORT & CONVENIENCE

WINCHES

PROTECTION

AUDIO

STORAGE



# STORAGE



**BRING IT ALL.  
BRING IT ON.**

From opposite sides of the globe, some of the most capable machines in the off-road world meet a trusted outdoor adventure brand to deliver industry-exclusive, purpose-built roof racks, bed racks and accessories to help Polaris RANGER users have more fun and get more done. Increase storage capacity so you can go where you want with everything you need, organized to succeed.



**MAXIMIZE  
YOUR RIDE**

For decades, Rhino-Rack has built some of the world's highest quality racks, accessories and mounts for the widest variety of uses and conditions. So whether you use your machine for hard work, hunting, fishing, and more, you can bring it all — and bring it on!



**BUILD THE ULTIMATE  
UTILITY VEHICLE**

Transform your vehicle for work, play or anything in between with durable and easy-to-use roof and bed racks, load securing accessories and the latest in carrier technology.



**BUILT FOR  
THE LONG HAUL**

Rhino-Rack designs and builds award-winning racks, accessories and mounts to endure the most extreme uses and conditions.

## PICK YOUR RACK

## PICK YOUR MOUNT

## ACCESSORIZE IT



### REAR BED RACK / 3-SEAT ROOF RACK

- Can be used as Bed Rack or Roof Rack on 3-Seat models, depending on which mount is purchased. Bed Rack only on Crew models.
- Bed Rack and Roof Rack can be used together if both mounts are purchased

» **2889236**  
XP 1000 '18-23, 1000 '20-23, XP KINETIC '23, DIESEL '20-23



### ROOF RACK - CREW

» **2889237**  
CREW XP 1000 '19-23, CREW 1000 '20-23



### REAR BED RACK MOUNT

» **2889235**  
XP 1000 '18-23, 1000 '20-23, CREW XP 1000 '19-23, CREW 1000 '20-23, XP KINETIC '23, DIESEL '20-23

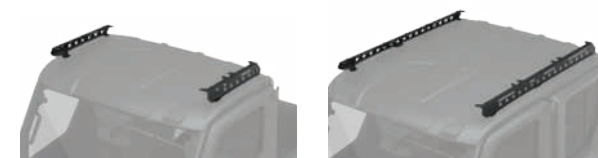

### ROOF RACK MOUNT

» **3-SEAT • 2889233**  
XP 1000 '18-23, 1000 '20-23, XP KINETIC '23, DIESEL '20-23

» **CREW • 2889234**  
CREW XP 1000 '19-23, CREW 1000 '20-23



### GUN MOUNTING BRACKET

- Bracket used to mount Kolpin Stronghold Gun Boots to Rhino-Rack systems when paired with Auto-Latch Mount (2884106), sold separately

» **2889327**  
XP 1000 '18-23, CREW XP 1000 '19-23, CREW 1000 '20-23, 1000 '20-23, XP KINETIC '23, DIESEL '20-23



### EYELET TIE-DOWNS

- Includes one set and hardware (straps not included) and attaches in multiple places on the platform to use as additional tie-down points
- Anti-corrosive galvanized steel for heavy-duty strength and long life

» **2889527**  
XP 1000 '18-23, CREW XP 1000 '19-23, CREW 1000 '20-23, 1000 '20-23, XP KINETIC '23, DIESEL '20-23

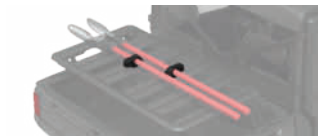

### MULTI-PURPOSE TOOL HOLDER

- Carry and protect tools, paddles, and more during your ride
- Ratchet-locking mechanism for quick release with rubber inserts to secure accessories into place

» **2889528**  
XP 1000 '18-23, CREW XP 1000 '19-23, CREW 1000 '20-23, 1000 '20-23, XP KINETIC '23, DIESEL '20-23

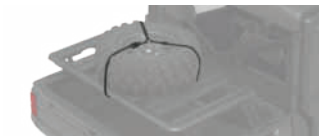

### SPARE TIRE HOLDER

- Transport your spare tire outside your vehicle
- Easily mounts to your Rhino-Rack Rear Bed Rack

» **2889529**  
XP 1000 '18-23, CREW XP 1000 '19-23, CREW 1000 '20-23, 1000 '20-23, XP KINETIC '23, DIESEL '20-23



### TRACTION BOARD MOUNT

- Strong, durable mount is easy to attach to the Rhino-Rack platform
- Traction board not included

» **2889530**  
XP 1000 '18-23, CREW XP 1000 '19-23, CREW 1000 '20-23, 1000 '20-23, XP KINETIC '23, DIESEL '20-23



### CARGO CORNER BRACKET

- Bring your Polaris Northstar cooler along while saving space inside your vehicle
- Unique anti-rotation nut for maximum cargo security

» **2889531**  
XP 1000 '18-23, CREW XP 1000 '19-23, CREW 1000 '20-23, 1000 '20-23, XP KINETIC '23, DIESEL '20-23



### HIGH-LIFTING JACK MOUNT

- Installs simply and quickly with durable brackets
- Rugged, non-corrosive powder-coated steel stands up to the harshest conditions

» **2889533**  
XP 1000 '18-23, CREW XP 1000 '19-23, CREW 1000 '20-23, 1000 '20-23, XP KINETIC '23, DIESEL '20-23



### **NEW** 200L LUGGAGE BAG

- Carry your bulky, light weight gear while on the road in this tear-resistant and weather-resistant canvas bag

» **2889881**  
XP 1000 '18-23, CREW XP 1000 '19-23, CREW 1000 '20-23, 1000 '20-23, XP KINETIC '23, DIESEL '20-23



# STORAGE

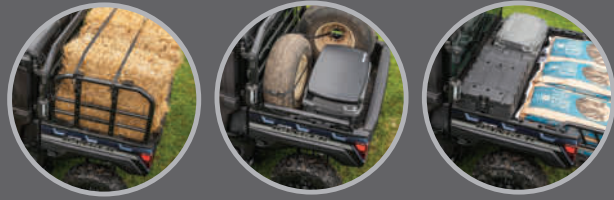

## LOCK & RIDE

Exclusive to Polaris, Lock & Ride accessories let you quickly change from one task to another with hundreds of options.

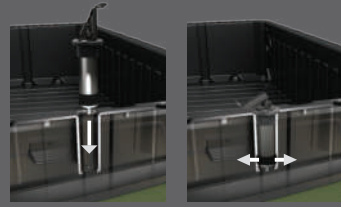

WITH THE FLIP OF A LEVER, LOCK & RIDE PLUNGERS USE OUTWARD PRESSURE TO EXPAND FOR A SECURE FIT.



1000 / XP 1000 / XP KINETIC / DIESEL

ROOFS

WINDSHIELDS

REAR PANELS

DOORS

CAB KITS

CAB COMFORT & CONVENIENCE

WINCHES

PROTECTION

AUDIO

STORAGE



### CARGO BED REAR WINCH



- Assists lifting heavy objects like hay bales or big game up into rear cargo bed
- 136 kg winch mounts high on rear cab frame
- Equipped with 4.6 m of premium synthetic rope

» 2884215

XP 1000 '18-23, CREW XP 1000 '19-23, CREW 1000 '20-23, 1000 '20-23, XP KINETIC '23, DIESEL '20-23 REQUIRES ROOF PULSE: 2882904



### LOCK & RIDE FRONT BRUSHGUARD STORAGE RACK

- Allows extra storage space in front of your vehicle
- Accommodates a Polaris Northstar 28 L Cooler or similar sized items
- Attaches and removes easily
- Mounts to existing plow mounting points

» 2883971

XP 1000 '18-23, CREW XP 1000 '19-23, CREW 1000 '20-23, 1000 '20-23, XP KINETIC '23, DIESEL '20-23



### LOCK & RIDE TIP-DOWN HEADACHE RACK TOP SELLER

- Rack tips down for additional storage solutions with space below and multiple tie-down points
- Lightweight and heavy-duty rack protects the cab of your RANGER and lets you haul even more

» 2881531

XP 1000 '17-23, CREW XP 1000 '18-23, CREW 1000 '20-23, 1000 '20-23, XP KINETIC '23, DIESEL '20-23



### LOCK & RIDE CARGOMAX SYSTEM

- Comes standard with a support bar that ties the two sides together for a sturdy cargo hold
- Designed to attach to the Lock & Ride Tip-Down Headache Rack for additional support and three-sided containment
- Adjustable utility hooks provide more options for hanging tools, cords or gear

» 2882177

XP 1000 '17-23, CREW XP 1000 '18-23, CREW 1000 '20-23, 1000 '20-23, XP KINETIC '23, DIESEL '20-23



### FRONT HOOD STORAGE RACK

- Front curve helps keep cargo in place when traveling
- Provides additional protection
- Fully integrated pivots to gain under-hood access
- Requires Bumper Adapter 2207941 when used with 7" Display powered by RIDE COMMAND

» 2882690

XP 1000 '18-23, CREW XP 1000 '19-23, CREW 1000 '20-23, 1000 '20-23, XP KINETIC '23, DIESEL '20-23 DOES NOT FIT WITH BUMPER 2882531, REQUIRES 2207941 TO WORK WITH FRONT CAMERA



### CANVAS STORAGE - CREW

- Attaches easily to the rear of the front seat in your crew vehicle
- Provides storage pockets for a variety of items, ensuring they're always within reach

» 2889268

CREW XP 1000 '18-23, CREW '20-23, DIESEL '20-23



### LOCK & RIDE BED EXTENDER/DIVIDER

- Extend or divide the cargo box
- Installs in any location in the box
- Multiple tie-down points available to secure cargo

» 2882752

XP 1000 '18-23, CREW XP 1000 '19-23, CREW 1000 '20-23, 1000 '20-23, XP KINETIC '23, DIESEL '20-23 DOES NOT FIT WITH CARGOMAX SYSTEM 2882177



## 75+ COMBINATIONS TO MAKE IT YOUR OWN

With a full line of Lock & Ride accessories, you can haul more and do more. Use the chart below to see what combinations work together.

POLARIS RANGER STORAGE MATRIX 1000 / XP 1000 / XP KINETIC 570 FULL-SIZE	LOCK & RIDE Tip-Down Headache Rack <small>TOP SELLER</small>	LOCK & RIDE CargoMax System	LOCK & RIDE Bed Extender/Divider	LOCK & RIDE Storage Box	LOCK & RIDE Tool Rack	LOCK & RIDE Chainsaw Mount	LOCK & RIDE 60 Gallon Boomless Utility Sprayer	Cargo Bed Rear Winch	LOCK & RIDE Front Brushguard Storage Rack	Cargo Bed Mat	RHINO-RACK Roof Rack - 3-Seat	RHINO-RACK Bed Rack - 3-Seat & Crew	RHINO-RACK Roof Rack - Crew
	2881531	2882177	2882752	2883279	2881533	2879354	2879799	2884215	2883971	2882751	2889236	2889236	2889237
LOCK & RIDE Tip-Down Headache Rack <small>TOP SELLER</small>	2881531	✓	✓	✓		✓	✓		✓	✓	✓		✓
LOCK & RIDE CargoMax System	2882177	✓		✓ <sup>2</sup>					✓	✓	✓		✓
LOCK & RIDE Bed Extender/Divider	2882752	✓		✓	✓	✓		✓	✓	✓	✓		✓
LOCK & RIDE Storage Box	2883279	✓	✓ <sup>1</sup>	✓		✓		✓	✓	✓	✓		✓
LOCK & RIDE Tool Rack	2881533			✓	✓			✓	✓	✓	✓		✓
LOCK & RIDE Chainsaw Mount	2879354	✓		✓	✓		✓	✓	✓	✓	✓		✓
LOCK & RIDE 60 Gallon Boomless Utility Sprayer	2879799	✓			✓		✓	✓	✓	✓	✓		✓
Cargo Bed Rear Winch	2884215		✓	✓	✓	✓	✓		✓	✓	✓		✓
LOCK & RIDE Front Brushguard Storage Rack	2883971	✓	✓	✓	✓	✓	✓	✓		✓	✓	✓	✓
Cargo Bed Mat	2882751	✓	✓	✓	✓	✓	✓	✓	✓		✓	✓	✓
RHINO-RACK Roof Rack - 3-Seat	2889236	✓	✓	✓	✓	✓	✓	✓	✓	✓		✓	✓
RHINO-RACK Bed Rack - 3-Seat & Crew	2889236										✓		✓
RHINO-RACK Roof Rack - Crew	2889237	✓	✓	✓	✓	✓	✓	✓	✓	✓	✓	✓	

<sup>1</sup> Storage box at front of cargo box if not used with Tip-down Headache Rack

<sup>2</sup> Storage box at front of cargo box

### LOCK & RIDE QUICKSTRAP

- The quickest and most secure way to mount Polaris accessories
- Sold as a pair

» 2882187

ALL COOLERS, RANGER CARGO BOXES



### LOCK & RIDE D-RINGS TOP SELLER

- The most versatile Lock & Ride accessory - add as many as you need to secure your cargo with bungee cords or straps

» 2881545

ALL RANGER CARGO BOXES



### 3.8 cm x 4.6 m 2495 kg RATCHET STRAP

- Heavy-duty webbing
- 2,495 kg maximum load / 831 kg working load
- 2 Pack

» 2884031

### 5.1 cm x 6.1 m 4536 kg RATCHET STRAP

- Heavy-duty webbing
- 4,536 kg maximum load / 1,497 kg working load
- Floating D-Rings and Double J-Hooks

» 2884032



# STORAGE

## LOCK & RIDE CHAINSAW MOUNT

- Can be secured to the outside of the bed wall so your chainsaw is within reach at all times

» 2879354

XP 1000 '17-23, CREW XP 1000 '18-23, CREW 1000 '20-23, 1000 '20-23, XP KINETIC '23, DIESEL '20-23



## LOCK & RIDE 227 L BOOMLESS UTILITY SPRAYER

» 2879799

XP 1000 '17-23, CREW XP 1000 '18-23, CREW 1000 '20-23, 1000 '20-23, XP KINETIC '23, DIESEL '20-23



## BED ESSENTIALS

### FIRE EXTINGUISHER HOLDER

- Only holds a 8.3 cm diameter extinguisher
- Quick release strap allows for easy use

» 2882158

XP 1000 '17-23, CREW XP 1000 '18-23, CREW 1000 '20-23, 1000 '20-23, XP KINETIC '23, DIESEL '20-23



### ELECTRONIC CARGO BOX LIFT

» 2884141

XP 1000 '18-23, CREW XP 1000 '19-23, CREW 1000 '20-23, 1000 '20-23, XP KINETIC '23, DIESEL '20-23



### RIDE & REPAIR ESSENTIALS KIT

» 2881207

XP 1000 '17-23, CREW XP 1000 '18-23, CREW 1000 '20-23, 1000 '20-23, XP KINETIC '23, DIESEL '20-23



### CARGO BED MAT

- Non-slip surface to better secure loads and keep cargo bed clean

» 2882751

XP 1000 '18-23, CREW XP 1000 '19-23, CREW 1000 '20-23, 1000 '20-23, XP KINETIC '23, DIESEL '20-23



## TOW & HAUL



### TRAILER BALLS

» 5 cm WITH 1.9 cm SHANK 2877603

» 4.8 cm WITH 1.9 cm SHANK 2877602



### 5 cm BALL MOUNT

» 5 cm RECEIVER 2875320



### 3:1 HITCHES

» 5 cm x 5 cm RECEIVER 2830522

ALL RANGER MODELS  
» 3 cm x 3 cm RECEIVER 2830523  
ALL RANGER MODELS



» 4.8 cm REPLACEMENT BALL 2830524

ALL RANGER MODELS



### FRONT RECEIVER HITCH

» 5 cm WITH 1.9 cm SHANK 2884692

ALL RANGER MODELS



## TASK-SPECIFIC TOOLS

### LOCK & RIDE TOOL RACK

- Attach on the inside or outside of the cargo bed

» 2881533

XP 1000 '17-23, CREW XP 1000 '18-23, CREW 1000 '20-23, 1000 '20-23, XP KINETIC '23, DIESEL '20-23



## ORGANIZE & PROTECT

### LOCK & RIDE STORAGE BOX

- Enough room to store all the tools you need to get the job done
- Internal organizational dividers keep gear from rolling around
- Easily detaches from vehicle

» 2883279

XP 1000 '17-23, CREW XP 1000 '18-23, CREW 1000 '20-23, 1000 '20-23, XP KINETIC '23, DIESEL '20-23



## DO MORE:



**COOLERS**  
P. 48



**HUNT**  
P. 50

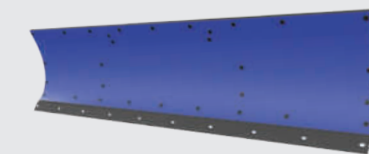

**COLD WEATHER**  
P. 52



**LIGHTING**  
P. 58



# CONNECTED TECHNOLOGY

## POLARIS RIDECOMMAND



COMMON ACCESSORIES  
CONNECTED TECHNOLOGY  
ELECTRICAL ACCESSORIES  
COOLERS  
HUNT  
COLD WEATHER  
PLOWES

LIGHTING  
WHEELS & TIRES

# ENHANCE YOUR RIDE WITH RIDE COMMAND

### PLAN YOUR RIDE

Plan an epic ride with stops along the way, customize and adjust your path to maximize your route. You can even share your planned route with friends.

### WORK SMARTER

Plow Mode automatically raises and lowers the plow depending on the gear you're in, so that you can get your work done quicker.

### DISCOVER NEW TRAILS

With over 1,000,000 miles of trails available offline, you'll have the confidence to explore further, whether you have cellular coverage or not.

#### AVAILABLE ON RIDE COMMAND MODELS & AS AN ACCESSORY 7" DISPLAY POWERED BY RIDE COMMAND\*



- Bright, 7" touchscreen visible in all conditions
- **Camera Integration**  
Navigate with full view of your surroundings. Use the integrated rear camera to see others behind you while riding.
- **Personalized Audio Experience**  
Seamlessly pair your display via Bluetooth to wirelessly stream music and stay connected with call and text alerts.
- **Configurable Gauges**  
Customize your ride experience with elevation, travel direction, fuel level and more to create relevant screens for you.
- **Plow Mode**  
Included on XP 1000 '18-20 and CREW XP 1000 '19-20 models (see P. 52 for details).

» 2884072  
XP 1000 '19-23, CREW XP 1000 '19-23, CREW 1000 '20-23, 1000 '20-23, XP KINETIC '23  
SPEAKERS NOT INCLUDED. MUST CHOOSE AUDIO PACKAGE FOR AUDIO OUTPUT

#### 7" DISPLAY MOUNT KIT



- Necessary mount for your 7" Display Powered by RIDE COMMAND
- Seamless fit and finish
- Includes necessary wiring harness and reverse camera kits

» 2889309  
XP 1000 '22-23, CREW XP 1000 '22-23,  
CREW 1000 '22-23, 1000 '22-23  
» 2889163  
SP 570 '22-23

#### FRONT CAMERA KIT

» 2889662  
XP KINETIC '23, SEE FULL DETAILS ON P. 15

\*Due to ongoing supply chain issues, there may be delayed or limited availability of this product as an accessory add-on.





# ELECTRICAL ACCESSORIES

Polaris PULSE is a revolutionary way to provide additional power locations on your vehicle, and makes adding electrical accessories a snap. Electrical accessories are easier to install on the roof, with designated routing areas and plug and play connections.

Look for to identify Polaris PULSE ready accessories.



## ADD ELECTRICAL SYSTEM ACCESSORIES IN 4 EASY STEPS

STEP 1				
CHOOSE A POLARIS PULSE READY ROOF	1000 / XP 1000 / XP KINETIC	CREW 1000 / XP 1000	SP 570	CREW SP 570
Premium Roof - Poly - Polaris Pursuit Camo	2882913	N/A	N/A	
Premium Roof - Poly - Black	2882912	N/A	N/A	
Sport Roof - Poly - Black	2882911	2889223	2885077	2885078

STEP 2				
ADD THE POLARIS PULSE ROOF 6	1000 / XP 1000 / XP KINETIC	CREW 1000 / XP 1000	SP 570	CREW SP 570
Polaris PULSE Roof 6	2882904			
Polaris PULSE Wiring Harness - Crew Extension	N/A		2889185	

STEP 3 ADD ACCESSORIES*				
POWER WINDOW DOORS	1000 / XP 1000 / XP KINETIC	CREW 1000 / XP 1000	SP 570	CREW SP 570
Polaris PULSE Wiring Harness - Crew Extension	N/A	2883231		N/A

STEP 4 FINISHING TOUCH				
CONCEAL WIRING FOR A FINISHED, COMFORTABLE LOOK	1000 / XP 1000 / XP KINETIC	CREW 1000 / XP 1000	SP 570	CREW SP 570
Premium Roof Liner	2882914	2883457	2885093	2885094

### THE FOLLOWING ACCESSORIES EASILY PLUG INTO THE FACTORY INSTALLED POLARIS PULSE UNDER THE HOOD:

	1000 / XP 1000	XP KINETIC	SP 570
8-Vent Heater & Defrost System	P. 28	P. 15	P. 78
Horn	P. 29	P. 29	P. 78
Plow Controller	P. 30	P. 30	P. 79
160 Watt, Waterproof AM/FM Bluetooth Audio System***	P. 34	P. 34	P. 78
Light Bars	P. 58	P. 58	P. 58



### POLARIS PULSE UNDERHOOD BUS BAR - 6 POSITION 1000 ONLY

\* If upgrading to more than three accessories attaching to the underhood PULSE location, replace 3-Position Bus Bar with the Polaris PULSE Underhood Bus Bar - 6 Position

» 2884183  
CREW 1000 '20-23, 1000 '20-23, DIESEL '20-23

### POLARIS FRONT PULSE BAR AND HARNESS

\* This kit is required to install any electrical accessories on a base RANGER SP 570

» 2889185  
SP 570 '22 (STANDARD ON 2023)

### POLARIS PULSE BATTERY TENDER ADAPTER

\* Connects your BatteryMINDER or trickle charger to your vehicle

» 2884297  
XP 1000 '18-21, CREW XP 1000 '19-23, CREW 1000 '20-23, 1000 '20-23, SP 570 '22-23, CREW SP 570 '22-23, XP KINETIC '23, DIESEL '20-23

### POLARIS PULSE READY ROOF WIRING EXAMPLE

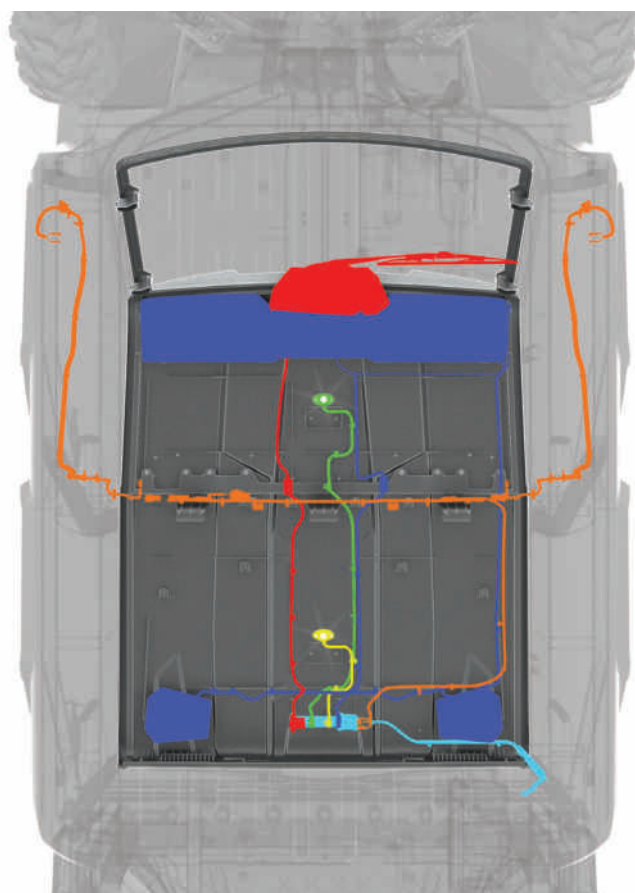

CREW XP 1000 POLARIS PULSE WIRING SHOWN

WINDSHIELD WIPER & WASHER SYSTEM	1000 / XP 1000 / XP KINETIC	CREW 1000 / XP 1000	SP 570	CREW SP 570
Windshield Wiper & Washer System	2883974			2885083
Polaris PULSE Wiring Harness - Crew Extension	N/A	2883231		2889185

AUDIO: VISOR AUDIO + REAR SPEAKERS	1000 / XP 1000 / XP KINETIC	CREW 1000 / XP 1000	SP 570	CREW SP 570
300 Watt AM/FM, Bluetooth Audio Visor with Four 16.5 cm Waterproof Speakers***	2882888			N/A
Rear Overhead Speakers	2882876			N/A
Polaris PULSE Wiring Harness - Crew Extension	N/A	2883231		N/A

AUDIO: DASH RADIO & VISOR SPEAKERS	1000 / XP 1000 / XP KINETIC	CREW 1000 / XP 1000	SP 570	CREW SP 570
160 Watt, Waterproof AM/FM Bluetooth Audio System***	2882750			N/A
300 Watt Overhead Audio Visor Speakers	2882891			N/A
JBL Dash Audio Kit	N/A			2885081
Polaris PULSE Wiring Harness - Crew Extension	N/A	2883231		2889185

WORK LIGHT	1000 / XP 1000 / XP KINETIC	CREW 1000 / XP 1000	SP 570	CREW SP 570
Rear LED Work Light	2889672			
Polaris PULSE Wiring Harness - Crew Extension	N/A	2883231		2889185

\*Add accessories to models without 7" Display Powered by RIDE COMMAND  
\*\*To add a Multi-Function Dome Light for rear passengers, add an additional 2882871

\*\*Check with your local dealer for availability.

### EASILY ADD LIGHTING

With Polaris PULSE it's easy to add RIGID and Pro Armor lighting to your RANGER. All LED Light bars listed on P. 58-59 are Polaris PULSE ready, making installation that much easier.

### POLARIS PULSE LIGHT BAR WIRING LOCATIONS

#### FRONT BUMPER // ROOF - FRONT MOUNTED // ROOF - REAR MOUNTED // \*CREW ROOF - REAR MOUNTED

\*Requires Extension

RANGER 1000 / XP 1000 / XP KINETIC	RANGER SP 570
1 LIGHT WITH 1 SWITCH	
» <b>TOP SELLER</b> Polaris PULSE Wiring Harness - 1 LED Light Bar - 2883230 + Upper Switch Panel Light Bar Harness** 2889675	Polaris PULSE Wiring Harness - 1 LED Light Bar - 2889161
2 LIGHTS WITH 1 SWITCH	
» <b>TOP SELLER</b> Polaris PULSE Wiring Harness - 1 LED Light Bar - 2883230 Y-Harness - 2879860	N/A
2 LIGHTS WITH 2 SWITCHES	
» <b>TOP SELLER</b> Polaris PULSE Wiring Harness - 1 LED Light Bar - 2883230 » <b>TOP SELLER</b> Polaris PULSE Wiring Harness - 1 LED Light Bar - 2883230	Polaris PULSE Wiring Harness - 1 LED Light Bar - 2889161 Polaris PULSE Wiring Harness - 1 LED Light Bar - 2889161
EXTENSIONS FOR CREW	
Polaris PULSE Wiring Harness - 1 LED Light Bar - Crew Extension 2883231 + Upper Switch Panel Light Bar Harness - Extension** 2890067	N/A

\*\*\* The FM Frequency range is from 88 to 108 and only on the odds (i.e. 88.1, 88.3, etc.).

COMMON ACCESSORIES

CONNECTED TECHNOLOGY

ELECTRICAL ACCESSORIES

COOLERS

HUNT

COLD WEATHER

PLOWS

LIGHTING

WHEELS & TIRES



KEEP IT  
**ICE COLD**

**GRIZZLY TESTED.**  
**POLARIS APPROVED.**



This cooler is IGBC-approved, meaning it withstands the power expended by a typical grizzly bear if it was trying to get inside.

Seriously, there are experts who know what a grizzly is capable of doing, and they certify our coolers can take it.



**28, 57 & 99**  
LITER FEATURES

- ComfortCarry  
Handles
- TravelLock  
System
- EasyOut  
Drain System
- NoSlip  
Rubber Feet
- PolarWall  
Insulation
- IceLock  
Seal

**POLARIS NORTHSTAR COOLERS CAN SURVIVE JUST ABOUT ANYTHING - FROM EXTREME HEAT TO A NASTY TUMBLE OFF A VEHICLE.**



**99 LITER**

- » GRAPHITE • 2883426
- » DESERT • 2883392



**57 LITER**

- » GRAPHITE • 2883425
- » DESERT • 2881259



**28 LITER**

- » GRAPHITE • 2883424
- » DESERT • 2881315



**14 LITER**

- » GRAPHITE • 2883968



**19 LITER SOFT-SIDED COOLER**

- » 2889285

**ESSENTIAL ACCESSORIES SO YOUR COOLER WORKS AS HARD AS YOU DO**

COOLER ACCESSORIES		99 LITER	57 LITER	28 LITER	DON'T FORGET THESE ACCESSORIES		
	<b>WIRE BASKET</b>	2883648	2882185	2882438			
	<b>DIVIDERS</b> Doubles as cutting board	2883468 COMES WITH ONE DIVIDER  1 way to partition	2882184 COMES WITH TWO DIVIDERS  2 ways to partition	2882186 COMES WITH ONE DIVIDER  1 way to partition			
	<b>SEAT CUSHION</b>	NOT AVAILABLE	2882179	2882507			
	<b>WHEELS</b>	2883967	2882180	NOT AVAILABLE	<p><b>TUMBLER</b> » 591 mL • 2883393</p> <p><b>LOCK &amp; RIDE QUICKSTRAP</b> » 2882187 ALL COOLERS AND POLARIS RANGER CARGO BOXES</p> <p><b>BOTTLE OPENER</b> » 2882183 ALL COOLERS</p>		



## PROTECTING YOUR ESSENTIAL GEAR SINCE 1943



### KOLPIN STRONGHOLD SYSTEM

Polaris is proud to partner with Kolpin Outdoors, an industry leader in off-road accessories and the premier name in gun boots and mounts. If you need to secure a firearm while riding, simply attach the auto-latch mount and choose your Gun Boot.

### IDEAL FOR SECURE TRANSPORT OF SCOPED RIFLES AND SHOTGUNS



#### STEP 1 CHOOSE YOUR MOUNT



**LOCK & RIDE** KOLPIN STRONGHOLD AUTO-LATCH DOUBLE BOOT MOUNT

- Precision angle adjustable for a custom fit
- Provides a quick and secure attachment point

» **DOUBLE BOOT MOUNT** • 2883970  
» **SINGLE BOOT MOUNT** • 2884106



**RHINO-RACK -  
GUN BOOT MOUNT**

- Bracket used to mount Kolpin Stronghold Gun Boots to Rhino-Rack systems when paired with Auto-Latch Mount (2884106), sold separately

» **2889327**  
XP 1000 '18-23, CREW XP 1000 '19-23, CREW 1000 '20-23, 1000 '20-23, DIESEL '20-23  
REQUIRES AUTO-LATCH MOUNT 2884106 TO MOUNT TO VEHICLE  
SEE P. 38 FOR MORE RHINO-RACK PRODUCTS

#### STEP 2 CHOOSE YOUR BOOTS



**KOLPIN STRONGHOLD  
GUN BOOT XL**

- Lockable and TSA approved
- Includes padded, zippered internal protective liner
- 132 cm L x 9.5 cm W x 26.7 cm H

» **2882036**  
REQUIRES AUTO-LATCH MOUNT 2883970 OR 2884106 TO MOUNT TO VEHICLE

**KOLPIN STRONGHOLD  
GUN BOOT L**

- 132 cm L x 12 cm W x 23.5 cm H

» **2882426**  
REQUIRES AUTO-LATCH MOUNT 2883970 OR 2884106 TO MOUNT TO VEHICLE



**CARGO BED REAR WINCH**

- Assists lifting heavy objects like hay bales or big game up into rear cargo bed
- 136 kg winch mounts high on rear cab frame
- Equipped with 4.6 m of premium synthetic rope

» **2884215**  
XP 1000 '18-23, CREW XP 1000 '19-23, CREW 1000 '20-23, 1000 '20-23, DIESEL '20-23



### **LOCK & RIDE** GUN RACK 6

- Adjustable to store guns at an angle or vertical (shown at angle)
- Holds six rifles or shotguns securely with soft rubber v-grips
- Stock is secured in place with a soft molded rubber inlay along the bottom of the rack
- Rack can be adjusted into three positions based on firearm height

» **2882159**  
XP 1000 '17-23, CREW XP 1000 '18-23, CREW 570 FULL SIZE '18-23, CREW 1000 '20-23, 570 FULL SIZE '17-23, 1000 '20-23, DIESEL '20-23



### IN-CAB GUN MOUNT

- Gives you instant gun access in the field
- Mounts securely to the floor and adjusts up to 45° forward
- Robust, molded gun butt holder at base
- Quick-release barrel straps
- Easily removable
- Accommodates scope-equipped rifles

» **2883263**  
XP 1000 '18-23, CREW XP 1000 '19-23, CREW 1000 '20-23, 1000 '20-23, DIESEL '20-23  
NORTHSTAR EDITION REQUIRES 2208023 HWD KIT TO INSTALL ON THE 2019 AND NEWER MODELS



### POLARIS PURSUIT CAMO SxS FIELD COVER

- Full-coverage camo print cover hides your side-by-side while in the field
- Lightweight material protects your RANGER from inclement weather

» **2882160**  
XP 1000 '18-23, EV '11-23, 570 FULL SIZE '17-23, 570 '14-21, SP 570 '22-23, 500 '11-23, 1000 '20-23, DIESEL '20-23

### KOLPIN RHINO GRIPS IDEAL FOR CARRYING RIFLES, SHOTGUNS, BOWS AND CROSSBOWS



**LOCK & RIDE  
RHINO GRIP PRO**

» **2884107**  
ALL RANGER MODELS (EXCEPT 150 EFI)



**LOCK & RIDE  
RATCHETING RHINO GRIP**

» **2881575**  
ALL RANGER MODELS (EXCEPT 150 EFI)



**LOCK & RIDE  
RHINO GRIP XLR**

» **2889165**  
ALL RANGER MODELS (EXCEPT 150 EFI)



**LOCK & RIDE  
RHINO GRIP XLR DOUBLES**

» **2889166**  
ALL RANGER MODELS (EXCEPT 150 EFI)



**RHINO GRIP  
PRO REPLACEMENT  
RUBBER STRAPS (2)**

» **2884109**  
RHINO GRIP PRO



**RHINO GRIP  
XLR REPLACEMENT  
RUBBER STRAPS (2)**

» **2889204**  
RHINO GRIP XL



# COLD WEATHER

GET READY FOR WINTER WITH PLOWS AND TRACKS.  
SEE P. 54 FOR PLOW DETAILS

## POLARIS PLOW MODE

EXCLUSIVE TO RANGER XP 1000 RIDE COMMAND FOR 2020-2023

7" DISPLAY POWERED BY RIDE COMMAND\*

» 2884072

XP 1000 '19-23, CREW XP 1000 '19-23, CREW 1000 '20-23, 1000 '20-23, XP KINETIC '23

SEE P. 44

Plow mode functionality does not control hydraulic lift and angle  
\*Due to ongoing supply chain issues, there may be delayed or limited availability of this product as an accessory add-on.



PLOW IS AUTOMATICALLY LOWERED WHEN SHIFTING INTO LOW

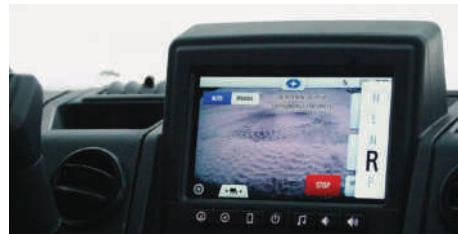

PLOW IS AUTOMATICALLY RAISED WHEN SHIFTING INTO REVERSE



BACK DRAG MODE ALLOWS FOR PULLING SNOW AWAY FROM BUILDINGS

## PROSPECTOR PRO TRACK SYSTEM

### PROSPECTOR PRO TRACK MOUNT KIT

• Install this track system mounting hardware in place of tires and wheels. Tracks sold separately.

» 2889425

XP 1000 '21-23, CREW XP 1000 '21, CREW 1000 '20-23, 1000 '21-23, DIESEL '20-23. FITS MODELS WITH NON-HIGH CLEARANCE A-ARMS

» 2889426

XP 1000 '21-23, CREW XP 1000 '21-23. FITS MODELS WITH HIGH CLEARANCE A-ARMS

» 2882783

XP 1000 '18-21, CREW XP 1000 '19-21, CREW 1000 '20-21, 1000 '20-21

» 2880071

CREW 570-4 '15-21, 570 '14-21, 500 '17-22

» **NEW** 2889196

SP 570 '22-23  
REQUIRES 2880758, SOLD SEPARATELY

### **NEW** PROSPECTOR PRO 2.0 TRACK

» 2890034

XP 1000 '18-23, CREW XP 1000 '18-23, CREW 1000 '20-23, 1000 '20-23, DIESEL '20-23

» 2889487

SP 570 '22-23, CREW SP 570 '22-23

### PROSPECTOR PRO TRACK

» 2880758

570 '14-21 WITH EPS, CREW 570 '14-21 WITH EPS

» 2880757

CREW 570-4 '14-21, 570 '14-21, 500 '17-22

If using Glacier Pro Plow System with tracks, Track Plow Extension is required (2889267)

For year-round use, Polaris recommends the use of Intake Update Kit (2880673) on any RANGER XP 1000 '17, RANGER XP 1000 CREW '14-18 with tracks installed. To keep intake system working optimally, this kit pre-filters out fine snow and dust.



#### 1 INDUSTRY'S FIRST - FLEX-TRACK DESIGN

Front-mounted tracks with flexible sides and slight curve toward the inside to allow stable handling, a more comfortable ride, and precise steering for long-distance riding and long working hours.

#### 4 TANDEM STABILIZER

Bolt-on tandem mid-roller wheel provides a smoother ride by absorbing shocks.

#### 2 HIGH-DENSITY TIRE WITH ADJUSTED SHAPE

With puncture-proof tires that reduce friction and wear, the Prospector Pro 2.0 Tracks delivers trouble-free performance.

#### 5 BEARING HOUSING

Outer seals and stainless steel sleeves allow stronger bearing durability and greater reliability.

#### 3 LIGHTWEIGHT POWDER COAT STEEL FRAME

Proven geometry to improve durability and deliver capability in all conditions throughout the life of the tracks.

#### 6 WHEEL CAP & SEAL

Fitted wheel cap with bladder effect eliminates water absorption due to temperature variation. Ride in snow and mud and not worry about the track maintenance.

The lighter frame provides more flotation to stay on top of the snow and allows the tracks to easily shed snow, mud, and debris.



# Otter®

### FEATURES

- Fits 1-2 people
- 2.46 square meter
- Set up dimensions: 170.2 L x 151.1 W x 199.4 H cm
- Cover included
- 2 top sealable vents
- Front entry door with dual coil zippers
- 2 sewn-in TPU crack resistant windows
- Insulated corners for complete coverage
- Interior draft skirt with extra-long perimeter

### POLARIS RANGER COMPATIBLE MODELS



XP 1000 '15-23, CREW XP 1000 '16-23, CREW 1000 '20-23, 1000 '20-23, DIESEL '20-23



CREW 570 FULL SIZE '18-23, 570 FULL SIZE '17-23



XP KINETIC '23

### LOCK & RIDE

**Polaris XT Pro Lodge**  
by *Otter*

» 2882199

VEHICLE WITH TRACKS WILL REDUCE SITTING SPACE IN HOUSE SLIGHTLY

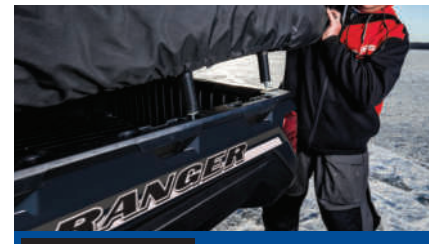

LOCK & RIDE Easy On & Off

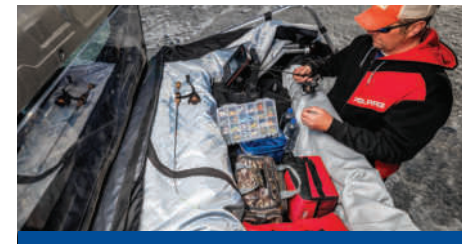

Room for Ice Fishing Gear



Comfortable Fishing for 2  
Seating not included

## EASY SET UP



## OtterTEC™



**OUTER SHELL**  
Provides outstanding wind and light blocking capabilities

**INNER LINING**  
The full thermal quilted inner shell provides higher lofting while locking in heat and virtually eliminating condensation



**LIGHTWEIGHT**  
Oversized square tube aluminum frame with anodized receiver tubes and ultra-glide operation



"The full-thermal Otter Ice House from Polaris sets up in minutes, is spacious enough for two anglers to fish in comfort and stows quickly on the back of your RANGER. It is the premium shelter solution for ice anglers that rely on their Polaris RANGER for mobility out on the ice."

- James Holst, InDepth Outdoors

Otter is a registered trademark of Otter Outdoors, LLC

### REAR 27" TIRE CHAINS

- Improve traction in deep snow and icy terrain
- Designed to fit on the 11" wide rear tires of the RANGER XP 1000

» 2889242

### **NEW** 29" TIRE CHAINS\*

- Improve traction in deep snow and icy terrain
- Wide enough to fit on the broader rear tires of the RANGER XP 1000

» 2889816

\*Check with your local dealer for availability.



BUILD A PLOW SYSTEM

CHOOSE A PLOW SYSTEM

# GLACIER PRO HD PLOW SYSTEM

## HYDRAULIC CONTROL FOR EXTREME SNOW REMOVAL

A robust frame and tough blades, combined with a convenient hydraulic angle system, allow your Glacier Pro HD to move serious snow while you remain comfortable. Thanks to Lock & Ride technology, the Pro HD comes standard with a convenient kickstand attachment to the plow frame, giving you the easiest attachment.

### 1000 / XP 1000 / XP KINETIC / DIESEL PLOW SYSTEMS (REQUIRES WINCH, SOLD SEPARATELY)

Choose a Glacier Pro HD Plow System, designed to help you get the most out of your RANGER during snowy months. Select a system based on your plowing needs with premium add-ons including a hydraulic lift system or additional plow accessories.

#### GLACIER PRO HD PLOW SYSTEM WITH HYDRAULICS & ACCESSORIES

- System includes:
- Frame (2889308)
  - 183 cm Poly Blade (2879317)
  - Hydraulic Angle (2889029)
  - Hydraulic Controller (2883247)
  - Plow Markers (2872726)
  - Back Drag Bar (2889329)
  - Plow Extensions (2889328)

» 3880002  
 XP 1000 '18-23, CREW XP 1000 '19-23, CREW 1000 '20-23, 1000 '20-23, XP KINETIC '23, DIESEL '20-23  
 REQUIRES LIFT METHOD: SEE WINCHES

#### GLACIER PRO HD PLOW SYSTEM WITH HYDRAULICS

- System includes:
- Frame (2889308)
  - 183 cm Poly Blade (2879317)
  - Hydraulic Angle (2889029)
  - Hydraulic Controller (2883247)
  - Plow Markers (2872726)

» 3880003  
 XP 1000 '18-23, CREW XP 1000 '19-23, CREW 1000 '20-23, 1000 '20-23, XP KINETIC '23, DIESEL '20-23  
 REQUIRES LIFT METHOD: SEE WINCHES

#### GLACIER PRO HD PLOW SYSTEM

- System includes:
- Frame (2889308)
  - 183 cm Steel Blade (2879874)
- » 3880004  
 XP 1000 '18-23, CREW XP 1000 '19-23, CREW 1000 '20-23, 1000 '20-23, XP KINETIC '23, DIESEL '20-23  
 REQUIRES LIFT METHOD: SEE WINCHES

### BUILD YOUR 1000 / XP 1000 / XP KINETIC PLOW SYSTEM

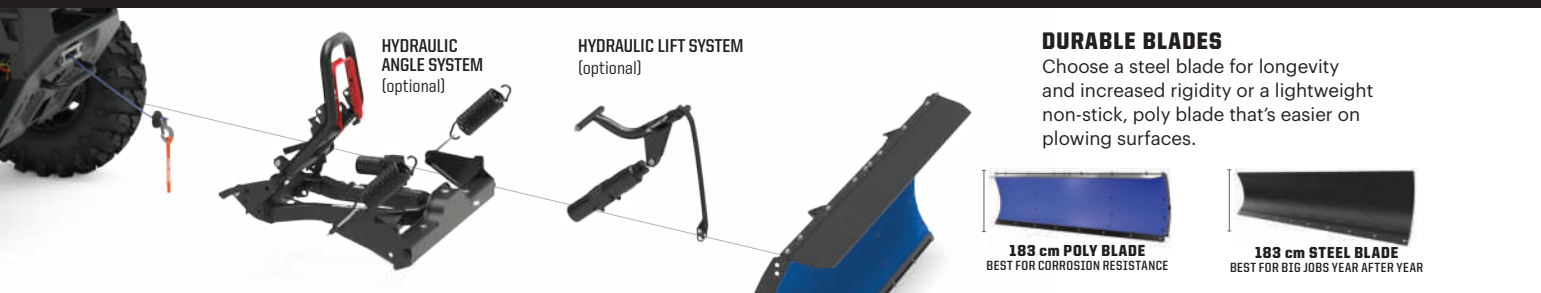

BUILD YOUR PLOW SYSTEM	STEP 1 SELECT A MOUNT	STEP 2 SELECT A FRAME	STEP 3 SELECT PLOW CONTROL		STEP 4 SELECT A BLADE
MODELS	MOUNT	FRAME	HYDRAULICS	WINCHES	BLADES
XP 1000 '18-23 CREW XP 1000 '19-23 1000 '20-23 CREW 1000 '20-23 XP KINETIC '23 DIESEL '20-23	Not Required Integrated into Factory Bumper  NON EPS RANGER 1000 REQUIRES FRONT BUMPER	Frame 2889308  Track Extension 2879871  Replacement T Shear Pin 2204829  Glacier Pro HD Kickstand System 2207382	Hydraulic Lift System 2889058  Glacier Pro HD Plow Hydraulic Angle System 2889029  Power Controller 2883247 REQUIRED FOR HYDRAULIC COMPONENTS	Polaris Pro HD 2,722 kg Winch 2882710  TOP SELLER Polaris Pro HD 2,041 kg Winch 2882711  Power Controller Winch Adapter 2884159	183 cm Poly 2879317  TOP SELLER 183 cm Steel 2879874

### SELECT ACCESSORIES

- |  |   |  |  |  |
|--|---|--|--|--|
| <b>PLOW BLADE SNOW DEFLECTOR</b><br>» 183 cm • 2858541<br>» 168 cm • 2879866<br>» 152 cm • 2871808 | <b>HEAVY-DUTY SNOW PLOW DEFLECTOR</b><br>» 183 cm • 2884160 | <b>QUICK RELEASE SKID SHOES</b><br>• Helps prevent blade wear<br>• Hardened steel for industrial strength<br>» 2205223 | <b>COIL SPRING SPACER</b><br>• Keep the front end of the vehicle up and improve ride quality when using a plow on strut or A-Arm vehicles<br>» 2872655 | <b>GLACIER 6" PLOW EXTENSIONS</b><br>• 6" steel plow extensions that attach to the side of 66" and 72" Glacier Pro HD plows<br>» 2889328 |
|--|---|--|--|--|



### POLARIS SP 570 PLOW SYSTEMS (REQUIRES WINCH, SOLD SEPARATELY)

- |   |   |   |
|---|---|---|
| <b>GLACIER PRO HD PLOW SYSTEM WITH HYDRAULICS</b><br>System includes:<br>• Quick Release Hook (2889577)<br>• Frame (2880260)<br>• 183 cm Steel Blade (2880270)<br>• Hydraulic Angle (2889032)<br>• Hydraulic Controller (2889162)<br>• Plow Markers (2872726)<br>» 3880006<br>SP 570 '22-23 & CREW SP 570 '22-23<br>REQUIRES LIFT METHOD: SEE WINCHES | <b>GLACIER PRO HD PLOW SYSTEM (NON BASE MODELS)</b><br>System includes:<br>• Quick Release Hook (2889577)<br>• Frame (2880260)<br>• 188 cm Poly Blade (2880269)<br>» 3880007<br>SP 570 '22-23 & CREW SP 570 '22-23<br>REQUIRES LIFT METHOD: SEE WINCHES AND HYDRAULIC LIFT OPTION | <b>GLACIER PRO HD PLOW SYSTEM (BASE MODELS ONLY)</b><br>System includes:<br>• Mount (2889195)<br>• Quick Release Hook (2889577)<br>• Frame (2880260)<br>• 188 cm Poly Blade (2880269)<br>» 3880008<br>SP 570 '22-23 & CREW SP 570 '22-23<br>REQUIRES LIFT METHOD: SEE WINCHES AND HYDRAULIC LIFT OPTION |
|---|---|---|

### BUILD YOUR SP 570/570/500/570 FULL-SIZE PLOW SYSTEM



BUILD YOUR PLOW SYSTEM	STEP 1 SELECT A MOUNT	STEP 2 SELECT A FRAME	STEP 3 SELECT PLOW CONTROL		STEP 4 SELECT A BLADE
MODELS	MOUNT	FRAME	HYDRAULICS	WINCH	BLADES
570 FULL-SIZE '16-23 CREW 570 FULL-SIZE '16-23 500 '10-23 570/CREW 570 '10-21 LI-ION EV & EV '15-22	Mount & Quick Release Hook 2880261	TOP SELLER Frame 2880260  Frame Extension 2880267 FOR VEHICLES USING TRACK SYSTEM  Replacement Shear Pin 2205527	Glacier Pro HD Plow Hydraulic Angle System 2889032  Power Controller 2879227 NO SHIFTER TO MOUNT CONTROLLER ON EV REQUIRED FOR HYDRAULIC COMPONENTS  Glacier Pro HD Plow Hydraulic Angle System 2889032  Power Controller 2889162 NO SHIFTER TO MOUNT CONTROLLER ON EV REQUIRED FOR HYDRAULIC COMPONENTS	Polaris Pro HD 2,041 kg Winch 2882238  Polaris Pro HD 2,041 kg Winch 2885096	TOP SELLER 183 cm Steel 2880270  168 cm Poly 2880269  TOP SELLER 168 cm Steel 2880268

- |   |   |  |  |                               |
|---|---|--|--|-------------------------------|
| <b>WEAR BARS</b><br>• Protect your plow blade and minimize wear on the actual blade<br>» 183 cm • 2204976<br>» 168 cm • 2879867<br>» 152 cm • 2877243<br>» HD 183 cm • 2879875<br>» HD 168 cm • 2879868 | <b>PLOW BACK DRAG BAR</b><br>• Has a hinged, rear facing cutting edge that improves back dragging performance and allows the bar to float when plowing forward to reduce wear and tear<br>» 2889329 | <b>QUICK RELEASE SKID SHOES</b><br>• Helps prevent blade wear<br>• Hardened steel for industrial strength<br>» 2208864 | <b>PLOW MARKER</b><br>• Helps driver monitor plow blade position<br>• Sold in pairs<br>» 2872726 | <b>PLOW LINK</b><br>» 2204974 |
|---|---|--|--|-------------------------------|



# GLACIER HD PLOW SYSTEM

## MAKE QUICK WORK OF THE SMALLER JOBS

Move some snow with the sturdy and capable Glacier HD plow system, and discover why a major snowfall can be the highlight of your week. With a robust frame, beefy poly and steel blade options, convenient Lock & Ride mounting and dismounting and amazing value, Glacier HD is a great choice in the dead of winter.



### 3-SEAT & CREW

» 183 cm or 168 cm Blades

» Choice of poly or steel

» Manual angle system standard

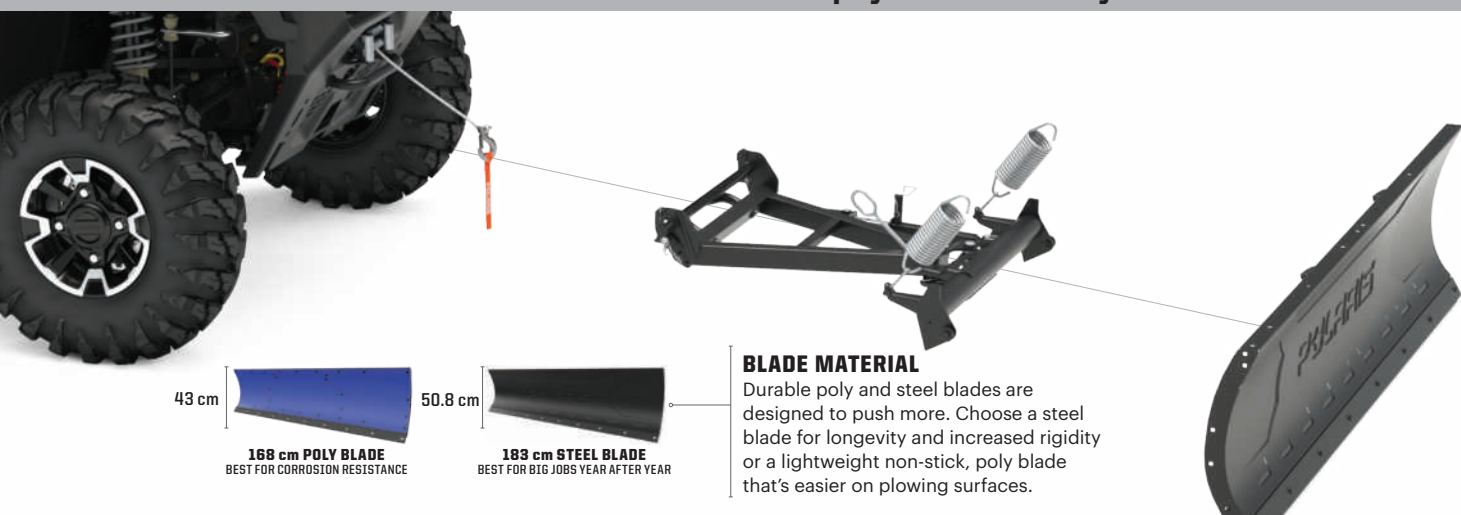

### 2-SEAT & CREW 570 FULL-SIZE & CREW

» 168 cm Blades

» Choice of poly or steel

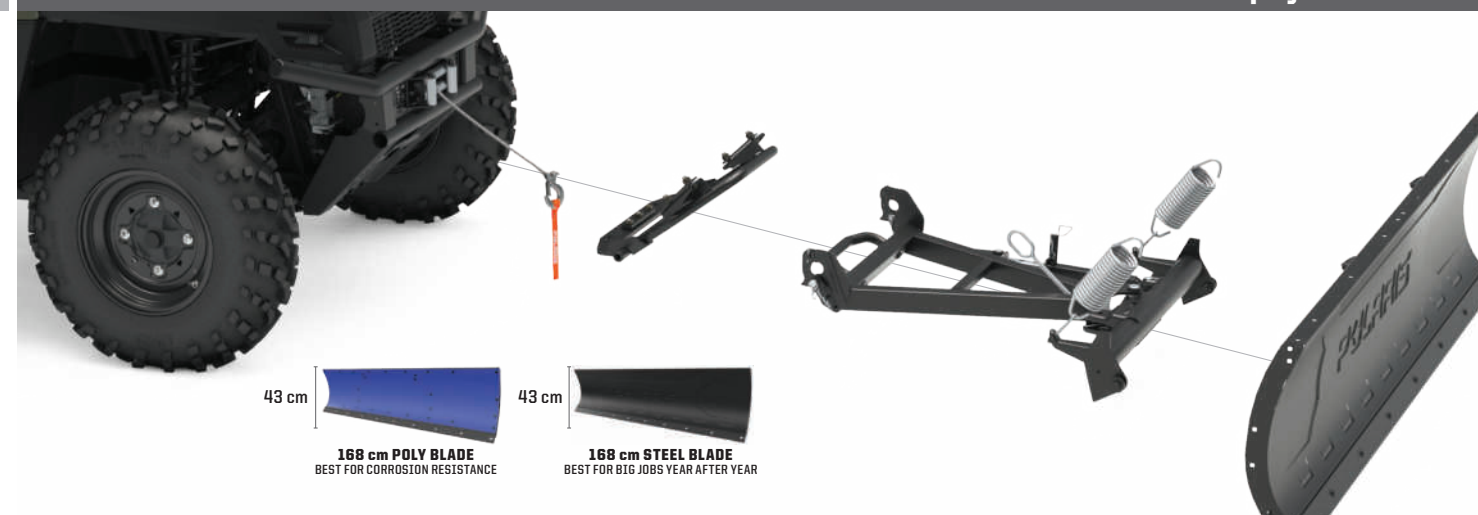

#### BLADE MATERIAL

Durable poly and steel blades are designed to push more. Choose a steel blade for longevity and increased rigidity or a lightweight non-stick, poly blade that's easier on plowing surfaces.

BUILD A PLOW SYSTEM				
	STEP 1 SELECT A MOUNT	STEP 2 SELECT A FRAME	STEP 3 SELECT A LIFT METHOD	STEP 4 SELECT A BLADE
MODELS	MOUNT	FRAME	WINCHES	BLADES
<b>XP 1000 '18-23</b> <b>CREW XP 1000 '19-23</b> <b>1000 '20-23</b> <b>CREW 1000 '20-23</b> <b>XP KINETIC '23</b> <b>DIESEL '20-23</b>  <small>NOT COMPATIBLE WITH 29" OR LARGER TIRES</small>	<b>Not Required</b> Integrated into Factory Brushguard  <small>NON EPS RANGER 1000 REQUIRES FRONT BUMPER</small>	<b>Frame</b> 2889307  <b>Replacement Shear Pin</b> 2205527	<small>TOP SELLER</small> <b>Polaris HD 2,041 kg Winch</b> 2882714	<small>TOP SELLER</small> <b>183 cm Steel</b> 2880270  <b>168 cm Poly</b> 2880269  <small>TOP SELLER</small> <b>168 cm Steel</b> 2880268

BUY A PLOW SYSTEM
<b>GLACIER HD PLOW SYSTEM</b>  System includes: • Frame (2889307) • 183 cm Steel Blade (2880270)  <b>» 3880005</b> XP 1000 '18-23, CREW XP 1000 '19-23, CREW 1000 '20-23, 1000 '20-23, XP KINETIC '23 <small>REQUIRES LIFT METHOD: SEE WINCHES</small>

BUILD A PLOW SYSTEM				
	STEP 1 SELECT A MOUNT	STEP 2 SELECT A FRAME	STEP 3 SELECT A LIFT METHOD	STEP 4 SELECT A BLADE
MODELS	MOUNT	FRAME	WINCHES	BLADES
<b>570 FULL-SIZE '16-23</b> <b>CREW 570 FULL-SIZE '16-23</b> <b>500/ETX '10-23</b> <b>570/CREW 570 '10-21</b> <b>LI-ION EV &amp; EV '15-22</b>	<b>Mount</b> 2879105	<b>Frame</b> 2889307	<small>TOP SELLER</small> <b>Polaris HD 1,588 kg Winch</b> 2881669	<b>168 cm Poly</b> 2880269
<b>SP 570/CREW SP 570 '22-23</b>	<b>Mount</b> 2889195 <small>NOT REQUIRED ON PREMIUM AND NORTHSTAR EDITION MODELS</small>	<b>Replacement Shear Pin</b> 2205527	<b>Polaris Pro HD 2,041 kg Winch</b> 2885096	<small>TOP SELLER</small> <b>168 cm Steel</b> 2880268

BUY A PLOW SYSTEM
<b>GLACIER HD PLOW SYSTEM</b>  System includes: • Frame (2889307) • 168 cm Steel Blade (2880268)  <b>» 3880009</b> SP 570 '22-23 & CREW SP 570 '22-23 <small>REQUIRES LIFT METHOD: SEE WINCHES</small>

### SELECT ACCESSORIES

WEAR BARS
• Protect your plow blade and minimize wear on the actual blade » 183 cm • 2204976 » 168 cm • 2879867 » 152 cm • 2877243 » HD 183 cm • 2879875 » HD 168 cm • 2879868

PLOW BLADE SNOW DEFLECTOR
» 183 cm • 2858541 » 168 cm • 2879866 » 152 cm • 2871808

HEAVY-DUTY SNOW PLOW DEFLECTOR
» 183 cm • 2884160

QUICK RELEASE SKID SHOES
• Helps prevent blade wear • Hardened steel for industrial strength » 2208864

COIL SPRING SPACER
• Keep the front end of the vehicle up and improve ride quality when using a plow on strut or A-Arm vehicles » 2872655

QUICK RELEASE SKID SHOES
• Helps prevent blade wear • Hardened steel for industrial strength » 2208864

PLOW MARKER
• Helps driver monitor plow blade position • Sold in pairs » 2872726

GLACIER PLOW LINK
» 2204974





**POLARIS ENGINEERED ADVANTAGES**

**MOUNTS PERFECTLY**  
Designed for your Polaris Engineered bumper, roof or other mounting point.

**MAX PERFORMANCE**  
Validated to work as hard as your machine does.

**DOESN'T OVERTAX**  
Trust it to work when you need it to.



**ADVANCED TECH**

RIGID lights are driven by Aluminum PCB Smart Boards™, 6063-T5 aircraft aluminum extruded housings and Tiger Drylac UV protection polyester powder-coating.

**EXCLUSIVE OPTICS**

RIGID lights feature impact-resistant polycarbonate lenses for a 100% water/dust proof seal.

**RUGGED CONSTRUCTION**

Pro Armor lights are designed to be big and beefy with an aggressive style all their own, and housed in IP67 marine-grade rated UV polyester powder coating.

**MASSIVELY BRIGHT**

Pro Armor builds bright lights designed for any riding experience. All that power is directed through heat dissipating aluminum for streamlined heat management.

**LIGHT BAR TYPES**



**SR-SERIES PRO**

Sleek, powerful, low-profile (under 5 cm tall). Lights extreme distances with low energy usage.

Available in 25 cm & 81 cm



**D-SERIES PRO**

Compact to fit almost anywhere with high output and low energy usage.

Available in Driving, Flood & Spot



**DUAL-ROW LED**

The most spread and farthest illumination downrange. Easy to mount.

Available in 27.9 cm & 78.7 cm



**SINGLE-ROW LED**

Powerful, compact, low-profile light bars with sleek look.

Available in 27.9 cm, 50.8 cm, 84 cm & 102 cm



**CUBE LED**

Small size allows mounting in strategic locations for added lighting.

Available in Spot

**LIGHT BAR OPTIONS**

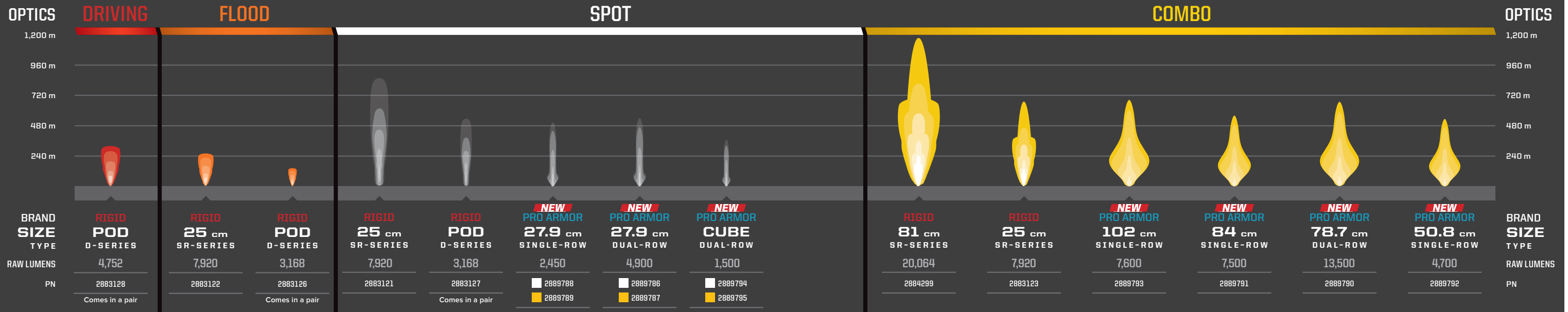

**BUILD YOUR VISION**

Consider the optics, angle & how you will use your vehicle to choose the right light or set of lights.

OPTICS LIGHT ANGLE	ACCENT	DRIVING (45°)	FLOOD (25°)	SPOT (10°)	COMBO (25°/10°)
DRIVING SPEED	All	Slow	Medium	Fast	Medium to fast
BEAM	Diffused glow	Extra-wide	Wide/Shorter	Concentrated/Long	Inner spot & outer flood
RECOMMENDED MOUNTING	Low/Wheel well	All points	Low &/or rear	High points	All points
TERRAIN & RIDING STYLE	Added style & personalization in any terrain	All riding & utility	Wide-open terrain or trails & utility	Trail & tight conditions	All riding & utility

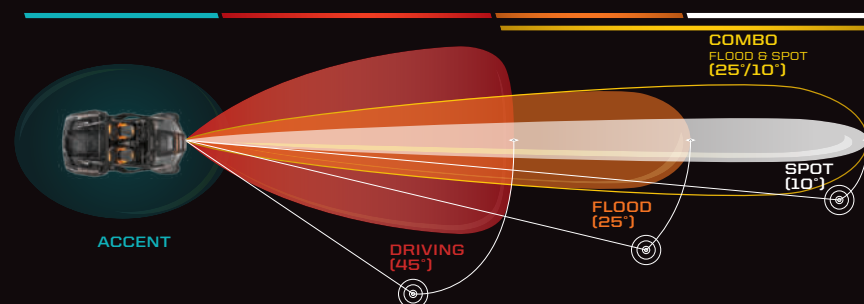

**ADD A HARNESS TO MOUNT YOUR LIGHTS**

MODEL	LIGHT BAR SET-UPS		
	1 LIGHT IN 1 LOCATION ON 1 SWITCH	2 LIGHTS IN 2 LOCATIONS ON 1 SWITCH	2 LIGHTS IN 2 LOCATIONS ON 2 SWITCHES
EV '15-22, CREW 570-4 '15-21, CREW 570 FULL SIZE '18-23, 570 FULL SIZE '17-23, 570 '15-21, 500 '17-22	⚠ Requires Battery Connection Cable <b>TOP SELLER</b> LIGHT BAR HARNESS 2882209 UPPER SWITCH PANEL LIGHT BAR HARNESS* 2889675	⚠ Requires Battery Connection Cable <b>TOP SELLER</b> LIGHT BAR HARNESS 2882209 Y-HARNESS 2879860	⚠ Requires Battery Connection Cable <b>TOP SELLER</b> LIGHT BAR HARNESS (X2) 2882209
SP 570 '22-23 NON-PREMIUM AND NON-NORTHSTAR MODELS REQUIRE BATTERY CONNECTION CABLE			
XP 1000 '18-21, CREW XP 1000 '19-21, 1000 '20-21, CREW 1000 '20-21, XP KINETIC '23, DIESEL '20-23			

SEE P. 46 FOR PULSE WIRING CONNECTIONS

**1 LED LIGHT BAR WIRING HARNESS - REAR FACING CREW EXTENSION**

• For installing rear facing light on Crew models  
 » 2883854  
 XP 1000 '20-23, CREW XP 1000 '19-23, CREW 1000 '20-23 TO BE USED WITH LIGHT BAR HARNESS (2889675)

**BATTERY CONNECTION CABLES 3-SEAT & CREW**

» 3-SEAT • 2889388  
 XP 1000 '17

» CREW • 2879685  
 CREW XP 1000 '17-18

**2-SEAT & CREW**

» **TOP SELLER** 2-SEAT • 2879990  
 EV '15-22, 570 '15-21, 500 '17-22

» 570 • 2881684  
 EV '15-22, 570 '15-21, 500 '17-22

» CREW • 2880929  
 CREW 570-4 '15-21

» SP 570 • 2889185  
 SP 570 SPORT '22-23, CREW SP 570 SPORT '22-23

\*Check with your local dealer for availability.

**ADD ADDITIONAL EXTERNAL LIGHTING**

P. 29



COMMON ACCESSORIES

CONNECTED TECHNOLOGY

ELECTRICAL ACCESSORIES

COOLERS

HUNT

COLD WEATHER

PLOWS

LIGHTING

WHEELS & TIRES

59

58



# KNOW YOUR TERRAIN



- Tread patterns optimized for extreme traction
- Ideal for both hard pack and loose trail



- Flexible "grippy" tread
- Aggressive side bite



- Provides traction and durability
- Built to perform in hard sand, jagged rocks or any other extreme terrain



- Extra deep treads
- Self-cleaning lugs



- Paddles provide traction and durability in soft sand
- Built to float on top of sand



- Triple-belted sidewalls to resist puncture
- Purpose-built, long lasting tread patterns



- Handles extreme cold
- Holds shape and provides traction

# SUPERIOR PERFORMANCE & DURABILITY

# WAYS TO SHOP WHEELS & TIRES

## PRO ARMOR



### LIFELONG PERFORMANCE

- Every tire is designed and constructed with longevity in mind
- 3,000+ mile rated (4,828 kilometers)

### PREMIUM PROTECTION

- Pro Armor makes tires with extra protection exactly where it's needed most — the sidewall
- Triple-belted sidewalls keep your tires more resistant so you can keep going

### TOUGH TIRES

- Higher ply ratings mean added protection
- Pro Armor builds 8 or 10-ply rated tires for higher puncture-resistance

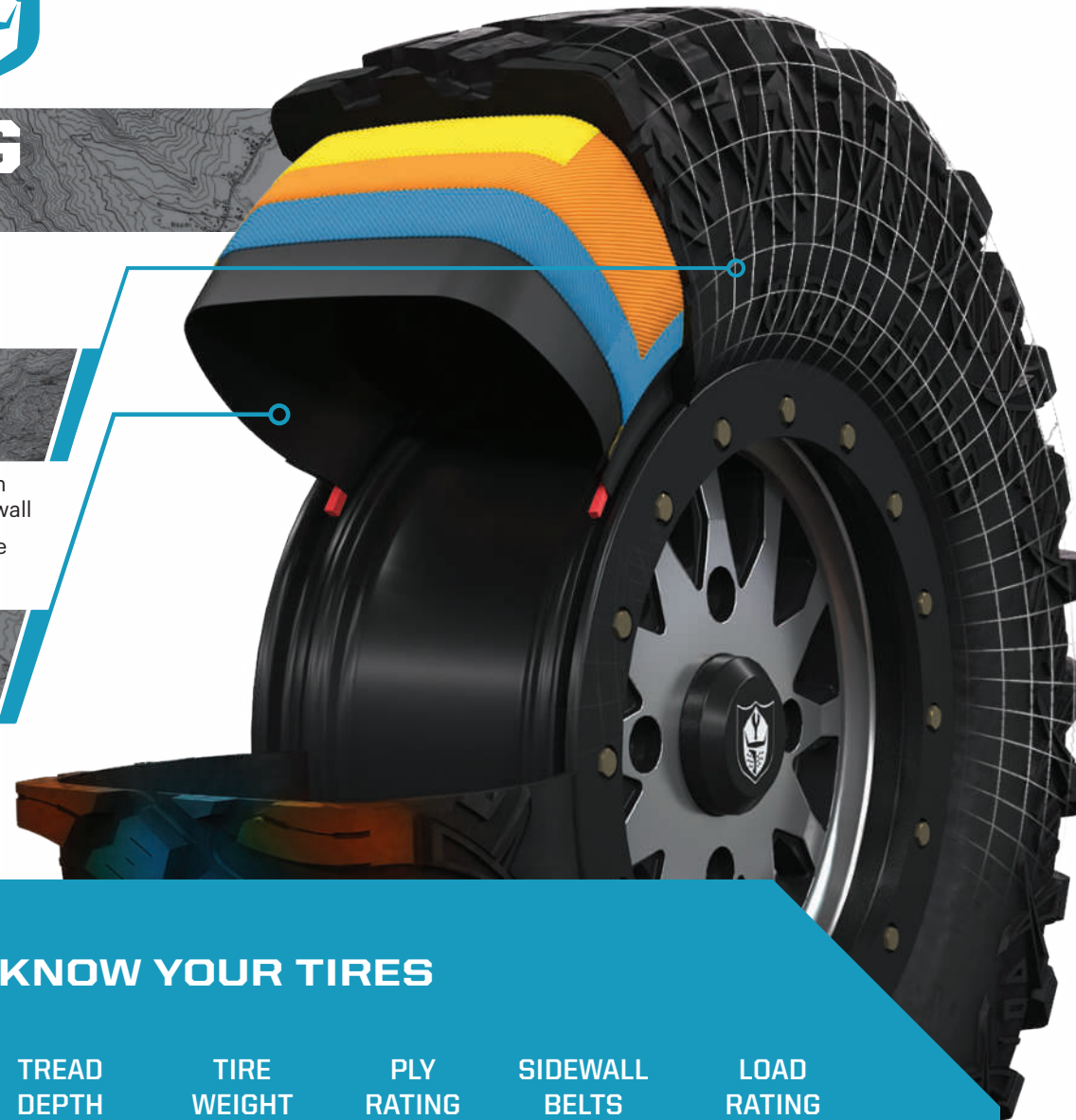

### TIRES BY SIZE

26"	27"	28"	29"
ATTACK	HARVESTER	ATTACK 2.0	DUAL-THREAT
DUAL-THREAT	MUD XC	CRAWLER XG	HD-K
HARVESTER	PRESERVE	CRAWLER XR	MUD XC
PRESERVE	X TERRAIN	HARVESTER	X TERRAIN
XD-K			

### TIRES BY TERRAIN

TRAIL	ROCK	DESERT	MUD	UTILITY	SNOW
ATTACK	CRAWLER XG	ATTACK	MUD XC	HARVESTER	ATTACK
ATTACK 2.0	CRAWLER XR	ATTACK 2.0		HD-K	ATTACK 2.0
CRAWLER XG	DUAL-THREAT	CRAWLER XG		PRESERVE	HARVESTER
CRAWLER XR		CRAWLER XR		XD-K	HD-K
DUAL-THREAT		DUAL-THREAT		X TERRAIN	XD-K
HARVESTER					
HD-K					
MUD XC					
PRESERVE					
XD-K					
X TERRAIN					

### KNOW YOUR TIRES

DIMENSIONS			TREAD DEPTH	TIRE WEIGHT	PLY RATING	SIDEWALL BELTS	LOAD RATING
TIRE HEIGHT	TIRE WIDTH	WHEEL DIAMETER					
32" x 9"	R15	FRONT/REAR	30 mm	18 kg	10	3	499 kg
<b>USAGE</b> Where can you use the tire			<b>TREAD DEPTH</b> Deeper treads have more grip in all conditions	<b>TIRE WEIGHT</b> A lighter tire makes for improved vehicle performance	<b>PLY RATING</b> Indicates tire puncture-resistance	<b>SIDEWALL BELTS</b> Increase your resistance to sidewall punctures	<b>LOAD RATING</b> How much weight can the tire handle

### WHEELS BY SIZE

14"	15"
40-SERIES (18 TIRE OPTIONS)	50-SERIES (2 TIRE OPTIONS)
4201	5201
4202	5202
4203 BEADLOCK	5203 BEADLOCK
4204	5204
4205	5301 BEADLOCK
4301 BEADLOCK	
HD DUAL BEADLOCK	

### KNOW YOUR WHEELS

- STEP 1: SELECT YOUR SERIES**  
4 = 40-SERIES    5 = 50-SERIES
- STEP 2: CHOOSE YOUR LOAD RATING**  
1 = <362.9 kg    2 = 363 - 589.7 kg    3 = 590 - 726 kg
- STEP 3: PICK YOUR STYLE**  
OFFSET / BEADLOCK / COLOR
- INCREASE OFFSET FROM STOCK = NARROWER STANCE**  
**DECREASE OFFSET FROM STOCK = WIDER STANCE**

COMMON ACCESSORIES  
CONNECTED TECHNOLOGY  
ELECTRICAL ACCESSORIES  
COOLERS  
HUNT  
COLD WEATHER  
PLOW  
LIGHTING  
WHEELS & TIRES



# TIRES



FRONT/REAR

## NEW X TERRAIN

- Built to perform through the toughest obstacles on any trail
- Durability-driven design to provide a comfortable, confident ride
- 8-ply, triple-belted ballistic sidewalls resist punctures

	TREAD DEPTH	TIRE WEIGHT	PLY RATING	SIDEWALL BELTS	LOAD RATING
14" 27" x 9" R14 5418330	FRONT	12 kg	8	3	365 kg
14" 27" x 11" R14 5418331	REAR	14 kg			438 kg
14" 29" x 9" R14 5418332	FRONT	14 kg			499 kg
14" 29" x 11" R14 5418333	REAR	16 kg			599 kg



WHEEL SIZE

14"



FRONT/REAR

## PRO ARMOR HARVESTER

- All-around work horse with tread life of 8,047 km
- Tread pattern designed to withstand anything from the farmyard to the pastures and the trail
- With 10-ply, it can carry the load day in and day out

	TREAD DEPTH	TIRE WEIGHT	PLY RATING	SIDEWALL BELTS	LOAD RATING
12" 26" x 8" R12 5416396	FRONT	11 kg	10	3	388 kg
12" 26" x 10" R12 5415966	REAR	15 kg			615 kg
14" 27" x 10" R14 5415965	FRONT/REAR	15 kg			599 kg
14" 28" x 10" R14 5416347	FRONT/REAR	15 kg			630 kg



WHEEL SIZE

12" 14"

## PICKING THE RIGHT UTILITY TIRE

UTILITY FEATURE	PRESERVE	HARVESTER	XD-K	HD-K	X TERRAIN
<b>8,047 Kilometer Rated</b> Long life and performance	X	X			X
<b>10-Ply Rated</b> Higher ply ratings means added protection	X	X	X	X	
<b>Low Impact Tread</b> Easy on soil	X				
<b>Heavy-Duty Tread</b> Aggressive tread pattern for all day work on farms or ranches		X	X	X	X
<b>Turf-Friendly</b> Easy on grass and farm yard	X	X			X
<b>Aramid Fiber Belt</b> 5x times stronger than steel and lighter			X	X	
<b>Size Options</b> For exactly how you want to use your machine	26", 27"	26", 27", 28"	26"	29"	27", 29"



FRONT/REAR

## PRO ARMOR XD-K

- 26" Aramid fiber-belted tire to tackle any terrain
- Unique full-face tread design
- Harder durometer lugs promotes extended wear, increasing tire life

	TREAD DEPTH	TIRE WEIGHT	PLY RATING	SIDEWALL BELTS	LOAD RATING
12" 26" x 9" R12 5415756	FRONT	13 kg	10	3/1 Aramid Fiber Belt	388 kg
12" 26" x 11" R12 5415757	REAR	15 kg			499 kg



WHEEL SIZE

12"



FRONT/REAR

## PRO ARMOR PRESERVE

- Turf-friendly for areas where low-impact from tire tread is needed
- Rounded profile and special tread pattern to limit footprint

	TREAD DEPTH	TIRE WEIGHT	PLY RATING	SIDEWALL BELTS	LOAD RATING
12" 26" x 8" R12 5416403	FRONT	11 kg	10	3	388 kg
12" 26" x 10" R12 5416402	REAR	13 kg			599 kg
14" 27" x 10" R14 5416348	FRONT/REAR	13 kg			599 kg



WHEEL SIZE

12" 14"



FRONT/REAR

## PRO ARMOR HD-K

- Designed to provide a smooth ride and aggressive traction in all riding terrains
- Triple-belted sidewall provides extreme protection and extends the tire life
- Quad belt tread core offers superior protection and longer tread life

	TREAD DEPTH	TIRE WEIGHT	PLY RATING	SIDEWALL BELTS	LOAD RATING
14" 29" x 10" R14 5417507	FRONT/REAR	18 kg	10	3/1 Aramid	598 kg



WHEEL SIZE

14"



# TIRES



## PRO ARMOR CRAWLER XR

- Premium grip for all terrains, from the trail to the rocks
- Square block profile for even surface contact
- A tougher durometer than the XG to take on the toughest the trail has to offer

	TREAD DEPTH	TIRE WEIGHT	PLY RATING	SIDEWALL BELTS	LOAD RATING
14" 28" x 10" R14 5416340	16 mm	15 kg	8	3	517 kg



### XR SINGLE DUROMETER

- Smaller lug height, added rigidity and lateral stability when cornering
- Unique lug design excels in hard pack, fast terrain



## PRO ARMOR DUAL-THREAT

- Dual-compound technology and radial construction offer performance in all terrains
- Softer durometer rubber on outer edge for overall superior grip and feel
- Harder durometer rubber in the middle for increased traction during acceleration and longer tread life

	TREAD DEPTH	TIRE WEIGHT	PLY RATING	SIDEWALL BELTS	LOAD RATING
14" 26" x 9" R14 5416340	16 mm	12 kg	10	3	413 kg
14" 26" x 11" R14 5416341		14 kg			504 kg
14" 29" x 9" R14 5416342		14 kg			504 kg
14" 29" x 11" R14 5416343		16 kg			599 kg



### DUAL-COMPOUND = MORE GRIP + LONGER LIFE

Firmer Durometer Rubber = Longer Life

Softer Durometer Rubber = More Grip



## PRO ARMOR CRAWLER XG

- Built to crawl over all obstacles, both large and small
- A soft, sticky compound makes this tire ideal for both rock crawling and desert running
- 8-ply, triple-belted ballistic sidewalls resist punctures

	TREAD DEPTH	TIRE WEIGHT	PLY RATING	SIDEWALL BELTS	LOAD RATING
15" 28" x 10" R15 5416346	20 mm	15 kg	8	3	499 kg



### WHAT CRAWLER ARE YOU?

### XG DUAL-DUROMETER

- Taller lug height and dual-durometer construction
- Perfect balance between high-speed performance, durability and flex in order to grip slick rock



## PRO ARMOR ATTACK 2.0

- Engineered for excellent hard pack performance
- Dual-compound technology and radial construction offer performance in all terrains
- Tight tread pattern for quieter ride

	TREAD DEPTH	TIRE WEIGHT	PLY RATING	SIDEWALL BELTS	LOAD RATING
15" 28" x 10" R15 5416344	25 mm	15 kg	10	3	499 kg



TIGHTER TREAD PATTERN = Better traction in hard pack

DUAL-DUROMETER LUG = Increased grip & traction in rough terrain, smoother ride in all terrain

10-PLY RATED = Increased durability

LARGER SIZE OFFERING IN 28" = More ground clearance & trail traction



## PRO ARMOR MUD XC

- Designed as the perfect mud-trail crossover for a smooth ride on the trail and aggressive traction in the mud
- Dual-compound technology with harder durometer lugs promote extended wear, increasing tire life
- 10-ply construction means added protection in the toughest terrain

	TREAD DEPTH	TIRE WEIGHT	PLY RATING	SIDEWALL BELTS	LOAD RATING
14" 27" x 9" R14 5416947	30 mm	14 kg	10	3	531 kg
14" 27" x 11" R14 5416948		15 kg			599 kg
14" 29" x 10" R14 5416946		18 kg			630 kg



## PRO ARMOR ATTACK

- The best all-purpose tire for all-season traction in any terrain
- Unique, full-face tread design
- Harder durometer lugs promote extended wear, increasing tire life
- Wider spaced lugs provide more grip in softer terrain

	TREAD DEPTH	TIRE WEIGHT	PLY RATING	SIDEWALL BELTS	LOAD RATING
14" 26" x 9" R14 5415613	23 mm	13 kg	8	3	413 kg
14" 26" x 11" R14 5415614		15 kg			599 kg







• Tread patterns optimized for extreme traction  
• Ideal for both hard pack and loose trail



• Flexible "grippy" tread  
• Aggressive side bite



• Provides traction and durability  
• Built to perform in hard sand, jagged rocks or any other extreme terrain



• Extra deep treads  
• Self-cleaning lugs



• Paddles provide traction and durability in soft sand  
• Built to float on top of sand



• Triple-belted sidewalls to resist puncture  
• Purpose-built, long lasting tread patterns



• Handles extreme cold  
• Holds shape and provides traction

# WHEEL & TIRE SETS

14"

40-SERIES

## UTILITY

HARVESTER 27" 8,047 km



HARVESTER 28" 8,047 km



PRESERVE 27" 8,047 km



## DESERT/ROCK

CRAWLER XR 28" 4,828 km



## MUD/TRAIL

MUD XC 27" 4,828 km



MUD XC 29" 4,828 km



4201 Accent	2882388	2883225	2883208	2882394	2884272	2884265
4201 Matte Black	2882389	2883226	2883209	2882395	2884273	2884266
4202 Accent	2882383	2883220	2883203	2881343	2884267	2884260
4202 Matte Black	2882384	2883221	2883204	2881344	2884268	2884261
4203 BEADLOCK Matte Black BEADLOCKS SOLD SEPARATELY				2881386		
4204 Accent	2882385	2883222	2883205	2881355	2884270	2884263
4204 Matte Black	2882386	2883223		2881356	2884271	2884264
4205 Luster				2881371		
4205 Matte Black	2882387	2883224	2883207	2881372	2884269	2884262
4301 BEADLOCK Accent BEADLOCKS PRE-MOUNTED				2883213		
4301 BEADLOCK Matte Black BEADLOCKS PRE-MOUNTED				2883212		

## BACKCOUNTRY/TRAIL

DUAL-THREAT 26" 4,828 km



DUAL-THREAT 29" 4,828 km



ATTACK 26" 4,828 km



**NEW** X TERRAIN 27" 4,828 km



**NEW** X TERRAIN 29" 4,828 km



2883138	2883146	2882390	2889966	2889976
2883139	2883147	2882391	2889967	2889977
2883140	2883148	2881335	2889968	2889978
2883141	2883149	2881336	2889969	2889979
		2881381	2889972	2889982
2883142	2883150	2881347	2889973	2889983
2883143	2883151	2881348	2889974	2889984
		2881359		
2883144	2883152	2881360	2889975	2889985
2883217	2883219		2889970	2889980
2883216	2883218		2889971	2889981

15"

50-SERIES

## TRAIL

ATTACK 2.0 28" 4,828 km



## DESERT/ROCK

CRAWLER XG 28" 4,828 km



5201 Accent	2883160	2883188
5201 Matte Black	2883159	2883187
5202 Accent	2883158	2883186
5202 Matte Black	2883157	2883185
5203 BEADLOCK Accent BEADLOCKS SOLD SEPARATELY	2883154	2883182
5204 Matte Black	2883155	2883183
5301 BEADLOCK Accent BEADLOCKS PRE-MOUNTED	2883162	2883190
5301 BEADLOCK Matte Black BEADLOCKS PRE-MOUNTED	2883161	2883189

**2 WAYS TO PURCHASE**

INDIVIDUAL WHEELS & TIRES  
— OR —  
COMPLETE SETS AS LISTED

Exclusively at  
Polaris Authorized Dealers

## REPLACEMENT CAPS

POLARIS CAPS		PRO ARMOR CAPS			
LUSTER	ALL WHEELS EXCEPT 5204 & 5203 BEADLOCK	1521509-410	LUSTER	ALL WHEELS EXCEPT 5204 & 5203 BEADLOCK	5453209-410
MATTE BLACK		1521509-521	MATTE BLACK		5453209-458
LUSTER	5203 BEADLOCK	1522243-410	MATTE BLACK	5204	1523063-458
MATTE BLACK		1522243-458	LUSTER	5203 BEADLOCK	1523015-410
<b>HD</b> MATTE BLACK	ALL WHEELS	5457498-458	MATTE BLACK		

## LUG NUTS

LUG NUTS REQUIRED



### 12mm x 1.5 SPLINED LUG NUTS

16 LUG NUTS WITH WRENCH	ALL POLARIS RANGER 3-SEAT & CREW MODELS	2879332
4 LUG NUTS WITHOUT WRENCH		2879331
SPLINED LUG WRENCH		2204966

### 3/8" - 24 HEX LUG NUTS

16 HEX LUG NUTS	ALL POLARIS RANGER 570 '20-21 MODELS	2877409
4 HEX LUG NUTS		2876754





# WHEELS

15"

## 50-SERIES

**A 5201**

<b>WEIGHT:</b> 7.8 kg	<b>LOAD RATING:</b> 590 kg	<b>OFFSET:</b> +4
<b>ACCENT:</b> FRONT/REAR	15" x 7"	1523184-266
<b>MATTE BLACK:</b> FRONT/REAR	15" x 7"	1523184-458

**B 5202**

<b>WEIGHT:</b> 8.1 kg	<b>LOAD RATING:</b> 590 kg	<b>OFFSET:</b> +4
<b>ACCENT:</b> FRONT/REAR	15" x 7"	1523102-266
<b>MATTE BLACK:</b> FRONT/REAR	15" x 7"	1523102-458

**C 5203 BEADLOCK**

<b>WEIGHT:</b> 7.3 kg	<b>LOAD RATING:</b> 590 kg	<b>OFFSET:</b> +38
<b>MATTE BLACK:</b> FRONT/REAR	15" x 7"	1522435-458

**D 5204**

<b>WEIGHT:</b> 6.1 kg	<b>LOAD RATING:</b> 590 kg	<b>OFFSET:</b> +55
<b>MATTE BLACK:</b> FRONT/REAR	15" x 7"	1522550-458

**E 5301 BEADLOCK**

<b>WEIGHT:</b> 7.7 kg	<b>LOAD RATING:</b> 726 kg	<b>OFFSET:</b> +38
<b>ACCENT:</b> FRONT/REAR	15" x 7"	1523282
<b>MATTE BLACK:</b> FRONT/REAR	15" x 7"	1523266

### LUG NUTS

○ LUG NUTS REQUIRED SEE P. 67



14"

## 40-SERIES

**F 4201**

Front <b>WEIGHT:</b> 5.9 kg	<b>LOAD RATING:</b> 408 kg	<b>OFFSET:</b> +9
Rear <b>WEIGHT:</b> 6.4 kg	<b>LOAD RATING:</b> 590 kg	<b>OFFSET:</b> +9
<b>ACCENT:</b> FRONT	14" x 7"	1522956-266
<b>REAR</b>	14" x 8"	1522957-266
<b>MATTE BLACK:</b> FRONT	14" x 7"	1522956-458
<b>REAR</b>	14" x 8"	1522957-458

**G 4202**

Front <b>WEIGHT:</b> 5.8 kg	<b>LOAD RATING:</b> 408 kg	<b>OFFSET:</b> +4
Rear <b>WEIGHT:</b> 6.1 kg	<b>LOAD RATING:</b> 590 kg	<b>OFFSET:</b> -9
<b>ACCENT:</b> FRONT	14" x 7"	1522544-266
<b>REAR</b>	14" x 8"	1522545-266
<b>MATTE BLACK:</b> FRONT	14" x 7"	1522544-458
<b>REAR</b>	14" x 8"	1522545-458

**H 4203 BEADLOCK**

Front <b>WEIGHT:</b> 5.9 kg	<b>LOAD RATING:</b> 408 kg	<b>OFFSET:</b> +4
Rear <b>WEIGHT:</b> 6.6 kg	<b>LOAD RATING:</b> 590 kg	<b>OFFSET:</b> -9
<b>MATTE BLACK:</b> FRONT	14" x 7"	1522238-458
<b>REAR</b>	14" x 8"	1522239-458

**I 4204**

Front <b>WEIGHT:</b> 5.9 kg	<b>LOAD RATING:</b> 408 kg	<b>OFFSET:</b> +4
Rear <b>WEIGHT:</b> 6.4 kg	<b>LOAD RATING:</b> 590 kg	<b>OFFSET:</b> -9
<b>ACCENT:</b> FRONT	14" x 7"	1522546-266
<b>REAR</b>	14" x 8"	1522547-266
<b>MATTE BLACK:</b> FRONT	14" x 7"	1522546-458
<b>REAR</b>	14" x 8"	1522547-458

**J 4205**

Front <b>WEIGHT:</b> 4.8 kg	<b>LOAD RATING:</b> 408 kg	<b>OFFSET:</b> +4
Rear <b>WEIGHT:</b> 5.7 kg	<b>LOAD RATING:</b> 590 kg	<b>OFFSET:</b> -9
<b>MATTE BLACK:</b> FRONT	14" x 7"	1521507-521
<b>REAR</b>	14" x 8"	1521508-521
<b>LUSTER:</b> FRONT	14" x 7"	1521507-410
<b>REAR</b>	14" x 8"	1521508-410

**K 4301 BEADLOCK**

<b>WEIGHT:</b> 7.3 kg	<b>LOAD RATING:</b> 729 kg	<b>OFFSET:</b> +38
<b>ACCENT:</b> FRONT/REAR	14" x 7"	1523284
<b>MATTE BLACK:</b> FRONT/REAR	14" x 7"	1523283

**L HD DUAL BEADLOCK**

<b>WEIGHT:</b> 18.1 kg	<b>LOAD RATING:</b> 725.7 kg	<b>OFFSET:</b> +38
<b>MATTE BLACK:</b> FRONT/REAR	14" x 7"	1524022-458

## KNOW YOUR WHEELS

### STEP 1: SELECT YOUR SERIES

- 4 = 40-SERIES
- 5 = 50-SERIES

### STEP 2: CHOOSE YOUR LOAD RATING

- 1 = <362.9 kg
- 2 = 363 - 589.7 kg
- 3 = 590 - 726 kg

### STEP 3: PICK YOUR STYLE

- OFFSET / BEADLOCK / COLOR
- INCREASE OFFSET FROM STOCK = NARROWER STANCE
- DECREASE OFFSET FROM STOCK = WIDER STANCE

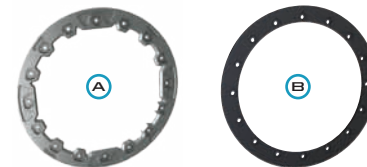

### 14" FORGED BEADLOCK RINGS

<b>A Machined</b> Only used on 4203 Beadlock & HD Dual Beadlock	1522244-266
<b>B Matte Black - Replacement</b> Only used on 4301 Beadlock & HD Dual Beadlock	1523146-458

### 15" FORGED BEADLOCK RINGS

<b>A Machined</b> Only used on 5203 Beadlock	1522240-266
<b>B Matte Black - Replacement</b> Only used on 5301 Beadlock	1523147-458

HD PARTS  
P. 102



For off-road use only. Please check fitment with your dealer.



# MAKE IT YOURS

**CUSTOMIZE YOUR RANGER SP 570 AND GET MORE DONE** with Polaris Engineered Accessories. Outfit your RANGER based on your riding preferences for added comfort, maximized storage, and more.

## RANGER SP 570 HUNT

2884106	<b>LOCK &amp; RIDE</b> Kolpin Stronghold Auto-Latch Boot Mount	P. 50	2889181	Rock Guard with Step - Crew	P. 79
2882036	Kolpin Stronghold Gun Boot XL	P. 50	2885087	Rear Brushguard	P. 79
2889791	Pro Armor 84 cm Combo LED Light Bar	P. 59	2885096	Polaris Pro HD 2,041 kg Winch with Rapid Rope Recovery	P. 79
2885078	Poly Crew Sport Roof	P. 72	2885088	Front Hood Storage Rack	P. 81



## RANGER SP 570 LANDOWNER

2885077	Poly 2-Seat Sport Roof	P. 72	2885096	Polaris Pro HD 2,041 kg Winch with Rapid Rope Recovery	P. 79
2889187	Convex Weatherproof Rear View Mirror	P. 78	2889189	Cargo Bed Mat	P. 80
2889243	Side View Mirrors - ROPS-Mounted	P. 78	2889199	<b>LOCK &amp; RIDE</b> Storage Box	P. 80



## RANGER SP 570 FARM

2885077	Poly 2-Seat Sport Roof	P. 72	2885087	Rear Brushguard	P. 79
2889187	Convex Weatherproof Rear View Mirror	P. 78	2885095	Polaris HD 1,588 kg Winch	P. 79
2889243	Side View Mirrors - ROPS-Mounted	P. 78	2889182	<b>LOCK &amp; RIDE</b> Tip-Down Headache Rack	P. 80
2885084	Upper Front Brushguard	P. 79	2889189	Cargo Bed Mat	P. 80



## RANGER CREW SP 570 TRAIL

2889791	Pro Armor 84 cm Combo LED Light Bar	P. 59	2889243	Side View Mirrors - ROPS-Mounted	P. 78
2885078	Poly Crew Sport Roof	P. 72	2889181	Rock Guard with Step - Crew	P. 79
2885080	<b>LOCK &amp; RIDE</b> Full Glass Windshield	P. 74	2885084	Upper Front Brushguard	P. 79
2879965	<b>LOCK &amp; RIDE</b> Rear Panel - Glass	P. 75	2885087	Rear Brushguard	P. 79
2885083	Windshield Wiper & Washer Kit	P. 78	2889183	<b>LOCK &amp; RIDE</b> Bed Extender/Divider	P. 80
2889187	Convex Weatherproof Rear View Mirror	P. 78			



# ROOFS



**SEALED COVERAGE**

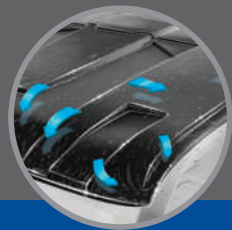

**REDUCE STANDING WATER**



**LOCK & RIDE**  
**EASY AND FAST INSTALLATION**

**POLARIS ENGINEERED ADVANTAGES**

## GLASS VS POLY

- Water run-off
- Mounting features: easily add accessories & lighting
- Liner ready
- Lightweight

- Heavy duty/durable
- Low profile
- Unique style

### SHIELD AGAINST DRIVING RAIN OR THE BLISTERING SUN.

Choose from poly or steel and know that you are protected from the elements with a seamless integrated roof.

## POLY

Lightweight, durable and impact-resistant. A poly roof can take the abuse of a tight trail and still protect.



### SPORT ROOF - POLY

- Offers reliable protection from the sun and rain
- Lightweight, durable polyethylene construction
- Simple one-time installation

- » **2-SEAT BLACK • 2885077**  
SP 570 '22-23
- » **CREW BLACK • 2885078**  
CREW SP 5770 '22-23

### PREMIUM ROOF LINER

- Cut in-cab noise by 60% at idle and by 40% at 20 mph
- One-piece liner attaches quickly and securely using push darts
- Adds premium comfort and quieter cab ride

- » **2-SEAT (shown) • 2885093**  
SP 570 '22-23
- » **CREW • 2885094**  
CREW SP 570 '22-23

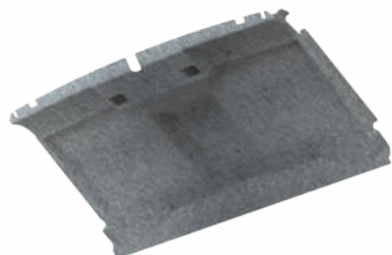

# DOORS



**PREMIUM FEATURES**



**UNPRECEDENTED VENTILATION OPTIONS**



**EASY AND FAST INSTALLATION**

**POLARIS ENGINEERED ADVANTAGES**

	POLY DOORS	CANVAS DOORS
<b>FRONT DOORS (SET OF 2)</b> SP 570 '22-23, CREW SP 570 '22-23	<p><b>CRANK WINDOW</b> Has manual crank windows for airflow adjustment in the cab with a fully finished black interior and exterior panels. Has a steel tube frame with a full 360 degree seal to keep out dust and rain.</p> <p><b>Manual Crank Window Doors 2885073</b> SHOWN WITH EXTERIOR DOOR ACCENT PANEL 2889389-795</p> 	<p><b>ZIP WINDOW</b> Heavy-duty 23-oz durable protection with adjustable zipper ventilation and see-through bottom panel. Powder-coated steel rod door frames provide strength and enhance fit and finish.</p> <p><b>Zip Window Doors 2885075</b></p> 
<b>REAR DOORS (SET OF 2)</b> CREW SP 570 '22-23	<p><b>Manual Crank Window Doors 2885074</b> SHOWN WITH EXTERIOR DOOR ACCENT PANEL 2889390-795</p> 	<p><b>Zip Window Doors 2885076</b></p> 

### EXTERIOR DOOR ACCENT PANELS

- Replace stock gloss black accent panels
- Painted plastic and clear-coated for UV protection
- Install easily with a single screw
- Comes as a pair
- Compatible with Poly doors only

	<b>NEW</b> Ghost Gray	Polaris Pursuit Camo	Sagebrush Green Non-Metallic	Polaris Blue Non-Metallic
FRONT	2889389-728	2889391-587	2889389-560	2889389-795
REAR	2889390-728	2889392-587	2889390-560	2889390-795





# WINDSHIELDS & REAR PANELS

## GLASS VS POLY

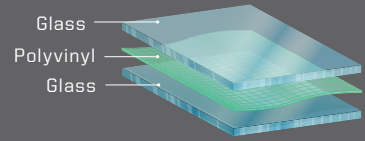

- Superior optical clarity (automotive level)
- Scratch-resistant
- Curved to fit, seals tight
- Cold weather / heavy duty
- Wiper ready (windshield only)

VS

- Lightweight, flexible, easy to store/remove
- Impact-resistant
- Tight seal keeps out rain and dust

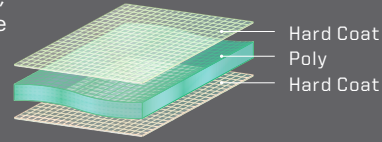

### LOCK & RIDE REVOLUTIONARY INSTALLATION



### AIRTIGHT GASKET SEAL

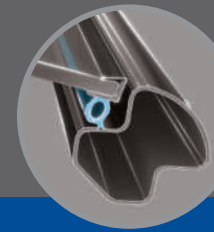

### VENTING OPTIONS

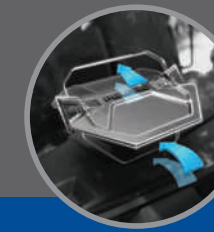

### MULTI-FUNCTION FEATURES



## POLARIS ENGINEERED ADVANTAGES

## WINDSHIELDS



### FULL TIP-OUT WINDSHIELD - GLASS

- Tip-out design offers three positions: open, closed and vented
- Gas shocks assist in easy opening and closing
- 360° gasket for reliable protection and comfort
- Scratch-resistant automotive-style curved glass
- Interior sound dampening and optimized visibility

» 2885079

SP 570 '22-23, CREW SP 570 '22-23



### FULL GLASS WINDSHIELD - CLEAR

- Scratch-resistant, curved laminate safety glass
- Protects against wind, rain and other hazardous debris
- UV-blocking interlayer and 360° gasket seal

» 2885080

SP 570 '22-23, CREW SP 570 '22-23



### LOCK & RIDE FULL WINDSHIELD - POLY TOP SELLER

- Durable, optical-grade, 0.6 cm-thick polycarbonate offers outstanding rider protection and visibility
- Windshield has minimal perimeter framework for full visibility

» 2883318

SP 570 '22-23, CREW SP 570 '22-23



### LOCK & RIDE HALF WINDSHIELD - POLY

- Strong, durable polycarbonate half windshield delivers a combination of protection and airflow into the cab
- Half windshield offers protection from rain, sleet, spray, and off-road hazards

» 2883320

SP 570 '22-23, CREW SP 570 '22-23



### LOCK & RIDE VENTED WINDSHIELD - HARD COAT POLY

- Frameless design for maximum visibility
- Added vents for airflow on a hot day or defrosting on a cold day

» 2883342

SP 570 '22-23, CREW SP 570 '22-23



### LOCK & RIDE FULL WINDSHIELD - HARD COAT POLY TOP SELLER

- Durable, optical-grade, 0.6 cm-thick polycarbonate offers outstanding rider protection and visibility
- Windshield has minimal perimeter framework for full visibility

» 2883319

SP 570 '22-23, CREW SP 570 '22-23



### LOCK & RIDE REAR PANEL - GLASS TOP SELLER

- Durable, tempered laminate glass provides a high level of scratch resistance

» 2879965

SP 570 '22-23, CREW SP 570 '22-23



### LOCK & RIDE REAR PANEL - POLY TOP SELLER

- Strong, 0.6 cm-thick polycarbonate provides outstanding impact and scratch resistance

» 2879812

SP 570 '22-23, CREW SP 570 '22-23

## HARD COAT POLY | 30x MORE SCRATCH-RESISTANT



### REDUCE IN-CAB DUST SWIRL BY ADDING A REAR PANEL

With a windshield and roof installed, turbulent air develops behind the cab. Add a rear panel to reduce dust intrusion from this swirl.



# CAB KITS

PICK YOUR OWN PACKAGE!

## FULL CAB

28K0007

2885077	Sport Roof - Poly - 2 Seat Black	P. 72
2885073	Manual Crank Window Doors - Poly	P. 73
2885080	Full Glass Windshield - Clear	P. 74
2879965	Rear Panel - Glass	P. 75
2885083	Windshield Wiper & Washer System	P. 78

SP 570 '22-23

2022 SP 570 & SP 570 HUNTER EDITION REQUIRE FRONT PULSE BAR AND HARNESSES 2889185



## HALF CAB

28K0008

2885077	Sport Roof - Poly - 2 Seat Black	P. 72
2885080	Full Glass Windshield - Clear	P. 74
2879812	Rear Panel - Poly	P. 75
2885083	Windshield Wiper & Washer System	P. 78

SP 570 '22-23  
2022 SP 570 & SP 570 HUNTER EDITION REQUIRE FRONT PULSE BAR AND HARNESSES 2889185



**ADD TO YOUR CAB COMFORT**  
WITH THE HEATER SYSTEM

### HEATER KIT P. 78

» 2885082  
SP 570 '22-23  
2022 SP 570 & SP 570 HUNTER EDITION REQUIRE FRONT PULSE BAR AND HARNESSES 2889185





# AUDIO



## JBL DASH AUDIO KIT

- System mounts into pre-designated locations in the vehicle dash
- Complete UTV audio solution gives your vehicle a performance-ready sound system
- Includes four off-road grade, water- and dust-proof speakers, and one head unit
- Head unit features AM/FM tuner\*, USB input and Bluetooth compatibility for wireless streaming



» 2885081  
SP 570 '22-23

## POLARIS RIDE COMMAND SEE P. 44 FOR MORE INFORMATION 7" DISPLAY POWERED BY RIDE COMMAND\*

» 2884072  
SP 570 '22-23  
SPEAKERS NOT INCLUDED



\*Due to ongoing supply chain issues, there may be delayed or limited availability of this product as an accessory add-on.

\* The FM Frequency range is from 88 to 108 and only on the odds (i.e. 88.1, 88.3, etc.).

## CONVENIENCE FEATURES

### CAB SEAL KIT

- Seal out dust from your UTV cab
- Reduces dust from getting on dash and seat

» 2889201  
SP 570 '22-23, CREW SP 570 '22-23  
(INCLUDED WITH PREMIUM DOORS)

### FRONT PULSE BAR AND HARNESS

- This kit is needed to install any electrical accessories to base vehicle

» 2-SEAT • 2889185  
SP 570 '22-23, CREW SP 570 '22-23  
» CREW • 2889568  
CREW SP 570 '22-23

### NEW ELECTRONIC POWER STEERING KIT

- Smoothest, most powerful electronic power steering available for your Polaris RANGER
- Variable assist for easier steering at lower speeds
- Greater responsiveness at higher speeds
- Front PULSE Bar required

» 2889464  
SP 570 '22-23, CREW SP 570 '22-23

### DOME LIGHT

- LED Dome light provides optimal visibility in the cab
- Easy to install

» 2889159  
SP 570 '22-23, CREW SP 570 '22-23  
2022 SP 570 & HUNTER EDITION REQUIRE FRONT PULSE BAR AND HARNESSES 2889185

### FLOOR MATS - FRONT

- Protects floors from dirt and wear
- Textured, non-slip surface

» 2889186  
SP 570 '22-23, CREW SP 570 '22-23

# CONVENIENCE FIELD TESTED INTERIOR

## ADD SUPERIOR ALL-WEATHER FUNCTIONALITY

and comfort to your RANGER with premium Polaris Engineered Accessories. Keep warm on the coldest of days with a heater kit and improve visibility with a Windshield Wiper and Washer System or Large Rear View Mirror.



### HEATER KIT

- Climate control for the cab of your off-road vehicle
- Total of four dash mounted vents with two positioned for defrosting the windshield and the other two for heating the cab
- Simple, dash-mounted controls
- Manually operated vents for airflow control

» 2885082  
SP 570 '22-23, CREW SP 570 '22-23  
2022 SP 570 & HUNTER EDITION REQUIRE FRONT PULSE BAR AND HARNESSES 2889185



### WINDSHIELD WIPER & WASHER KIT

- Helps clear hazardous dirt, rain and debris from your windshield
- » 2885083  
SP 570 '22-23, CREW SP 570 '22-23  
2022 SP 570 & HUNTER EDITION REQUIRE FRONT PULSE BAR AND HARNESSES 2889185



### CONVEX WEATHERPROOF REAR VIEW MIRROR

- Convex design for a broader view of traffic
- Durable, weatherproof construction
- Mount the bolts into your choice of pre-designated mounting locations
- Compatible with roof, windshield, and other accessories

» 2889187  
SP 570 '22-23, CREW SP 570 '22-23



### SIDE VIEW MIRRORS

- » DOOR MOUNTED (shown) • 2889241
- » ROPS-MOUNTED • 2889243  
SP 570 '22-23, CREW SP 570 '22-23

# PROTECTION



### UPPER FRONT BRUSHGUARD

- Made from tubular steel and provides additional protection for front fenders and headlights
- Attaches to stock front bumper
- Durable, scratch-resistant, black powder-coat finish

» 2885084  
SP 570 '22-23, CREW SP 570 '22-23  
NORDIC PRO MODELS ONLY.  
BASE MODELS REQUIRE 1026432-458  
NOT COMPATIBLE WITH 2885088



### REAR BRUSHGUARD

- Made from tubular steel and provides additional protection for taillights
- Durable, scratch-resistant, black powder-coat finish
- Reliably enhances back-end protection of vehicle

» 2885087  
SP 570 '22-23, CREW SP 570 '22-23



### ROCK GUARD WITH STEP

- Reliable, hard-working protection for edges of vehicle
- Mounts directly to the frame, instead of underneath, for maximum ground clearance

» 2-SEAT (shown) • 2889180  
SP 570 '22-23  
» CREW • 2889181  
CREW SP 570 '22-23



### A-ARM GUARDS

- Valuable, reliable protection for vital front suspension components exposed to the rigors of off-road environments

- Strong, durable, lightweight polyethylene construction withstands off-road impacts to protect the A-Arms

» FRONT (shown) • 2885097  
» REAR • 2880551  
SP 570 '22-23, CREW SP 570 '22-23

# WINCHES

FEATURES & BENEFITS	PRO PRO HEAVY DUTY SERIES	HD HEAVY DUTY SERIES	
<b>RAPID ROPE RECOVERY</b> Retrieve cable 5x as fast as standard mode on other Polaris winches. Get back to riding or complete your task quicker.	✓	NOT AVAILABLE	
<b>AUTO STOP TECHNOLOGY</b> Auto Stop technology protects and extends the life of your winch by automatically stopping the winch at the end of pull to prevent over-spooling.	✓	ADD AUTO STOP UPGRADE 2881693 SYNTHETIC ROPE REQUIRED	
<b>SYNTHETIC ROPE</b> Lightweight, extremely strong and flexible 50 ft long rope stands up to any tough job.	✓	ADD SYNTHETIC ROPE 2878888	
<b>WIRELESS REMOTE</b> Operate your winch wirelessly from within 50 ft of the vehicle.	WIRELESS STANDARD, WIRED OPTION	WIRED STANDARD, ADD WIRELESS REMOTE 2879316	
<b>MODEL</b>	<b>2,041 kg</b>	<b>1,588 kg</b>	<b>ADD REQUIRED CABLES</b>
<b>SP 570 '22-23 CREW SP 570 '22-23</b>	<b>2885096</b>	<b>TOP SELLER 2885095</b>	<b>2-SEAT &amp; CREW MODELS: 2889185</b>

## UPGRADE YOUR CONTROLS HD OR PRO HD WINCHES

- ### WIRED REMOTE CONTROL
- Must order remote handle and socket together
  - » REMOTE HANDLE 4013466
  - » SOCKET 4014228

- ### NEW POWER CONTROLLER
- Control your winch and plow hydraulics directly from the shift knob
  - » 2889162  
SP 570 '22-23





# STORAGE



## LOCK & RIDE®

Exclusive and available on all Polaris vehicles, Lock & Ride accessories let you quickly change from one task to another with hundreds of options.

WITH THE FLIP OF A LEVER, LOCK & RIDE PLUNGERS USE OUTWARD PRESSURE TO EXPAND FOR A SECURE FIT.

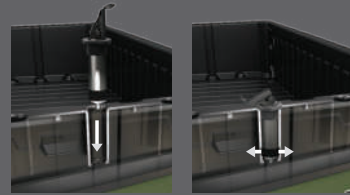

### LOCK & RIDE STORAGE BOX

- Provides enough room to store all the tools you need to get the job done
- Internal organizational dividers keep gear from rolling around
- Easily detaches from vehicle

» 2889199  
SP 570 '22-23, CREW SP 570 '22-23



### LOCK & RIDE TIP-DOWN HEADACHE RACK

- Provides extreme cargo versatility to your UTV
- Strong steel tube construction for maximum durability
- Installs and removes easily utilizing Lock & Ride technology

» 2889182  
SP 570 '22-23, CREW SP 570 '22-23

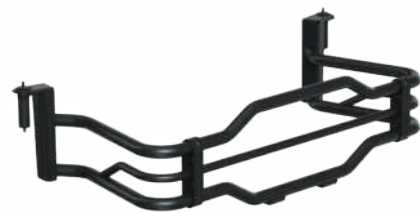

### LOCK & RIDE BED EXTENDER/DIVIDER

- Increase your cargo capacity and UTV storage
- Extend the cargo bed or divide cargo within the bed
- Lock & Ride technology for easy install without tools
- Made from durable steel and powder-coated finish

» 2889183  
SP 570 '22-23, CREW SP 570 '22-23



### CARGO BED MAT

- Protects cargo box, reduces drivetrain noise, and keeps cargo more secure with non-slip design
- Thick (3.18 mm) rubber mat construction

» 2889189  
SP 570 '22-23, CREW SP 570 '22-23



### LOCK & RIDE FRONT HOOD STORAGE RACK

- Increases load-carrying capacity and protects against brush and debris
- Steel construction with a durable powder-coated finish
- Lock & Ride functions for easy install, on and off maneuvering of the basket, and under-hood access
- Weight Capacity: 100 lbs.

» 2885088  
SP 570 '22-23, CREW SP 570 '22-23  
NORDIC PRO MODELS ONLY. BASE MODELS REQUIRE 1026432-458  
NOT COMPATIBLE WITH 2885084

### FIRE EXTINGUISHER HOLDER

- Quick-release strap allows for easy access

» 2882158  
SP 570 '22-23, CREW SP 570 '22-23

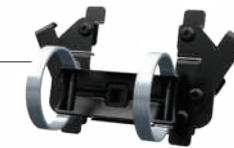

### RIDE & REPAIR ESSENTIALS KIT

» 2881207  
SP 570 '22-23, CREW SP 570 '22-23



### LOCK & RIDE D-RINGS TOP SELLER

- The most versatile Lock & Ride accessory - add as many as you need to secure your cargo with bungee cords or straps

» 2881545  
SP 570 '22-23, CREW SP 570 '22-23



### LOCK & RIDE CHAINSAW MOUNT

» 2879354  
SP 570 '22-23, CREW SP 570 '22-23



### LOCK & RIDE TOOL RACK

- Attach on the inside or outside of the cargo bed

» 2881533  
SP 570 '22-23, CREW SP 570 '22-23

## STRAPS

### 3.8 cm x 4.6 m 2494.8 kg RATCHET STRAP

- Heavy-duty webbing
- 2 Pack

» 2884031



### LOCK & RIDE QUICKSTRAP

- The quickest and most secure way to mount Polaris accessories
- Sold as a pair

» 2882187  
ALL COOLERS, RANGER CARGO BOXES



### 5.1 cm x 6.1 m 4535.9 kg RATCHET STRAP

- Heavy-duty webbing

» 2884032



## DO MORE:



**COOLERS**  
P. 48



**HUNT**  
P. 50

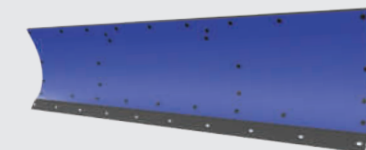

**COLD WEATHER**  
P. 52



**LIGHTING**  
P. 58



# MAKE IT YOURS

## WORK HARD AND GET IT DONE

with Polaris Engineered Accessories for your RANGER. Start with the ultimate in all-season performance and comfort with the best cab components in the industry. Find everything you need to outfit your RANGER for the task at hand.

### RANGER 570 HUNT

2882036	Kolpin Stronghold Gun Boot XL	P. 50
2885077	Poly 2-Seat Sport Roof	P. 84
2881784	<b>LOCK &amp; RIDE</b> Tip-Out Windshield - Glass	P. 86
2882238	Polaris Pro HD 2041 kg Winch	P. 91



### RANGER 570 WORK

2885077	Poly 2-Seat Sport Roof	P. 84
2882247	Hinged Window Doors - Poly	P. 85
2881784	<b>LOCK &amp; RIDE</b> Tip-Out Windshield - Glass	P. 86
2882238	Polaris Pro HD 2041 kg Winch	P. 91



### RANGER CREW 570-4 EPS RANCH

2883424	Polaris Northstar Cooler - 28 L	P. 48
2885078	Poly Sport Roof - Crew	P. 84
2879963	<b>LOCK &amp; RIDE</b> Canvas Door Set	P. 85
2881783	Glass Full Windshield, Clear	P. 86
2881533	<b>LOCK &amp; RIDE</b> Tool Rack	P. 93



### RANGER 500 TRAIL

2883425	Polaris Northstar Cooler - 57 L	P. 48
2885077	Poly 2-Seat Sport Roof	P. 84
2883320	<b>LOCK &amp; RIDE</b> Half Windshield - Poly	P. 87



# ROOFS

- SEALED COVERAGE**
- REDUCE STANDING WATER**
- LOCK & RIDE EASY AND FAST INSTALLATION**

POLARIS ENGINEERED ADVANTAGES

## POLY FEATURES

- Water run-off
- Mounting features: easily add accessories & lighting
- Liner ready
- Lightweight

### SHIELD AGAINST DRIVING RAIN OR THE BLISTERING SUN.

Know that you are protected from the elements with a seamless integrated roof. Poly is lightweight, durable and impact-resistant. A poly roof can take the abuse of a tight trail and still protect.

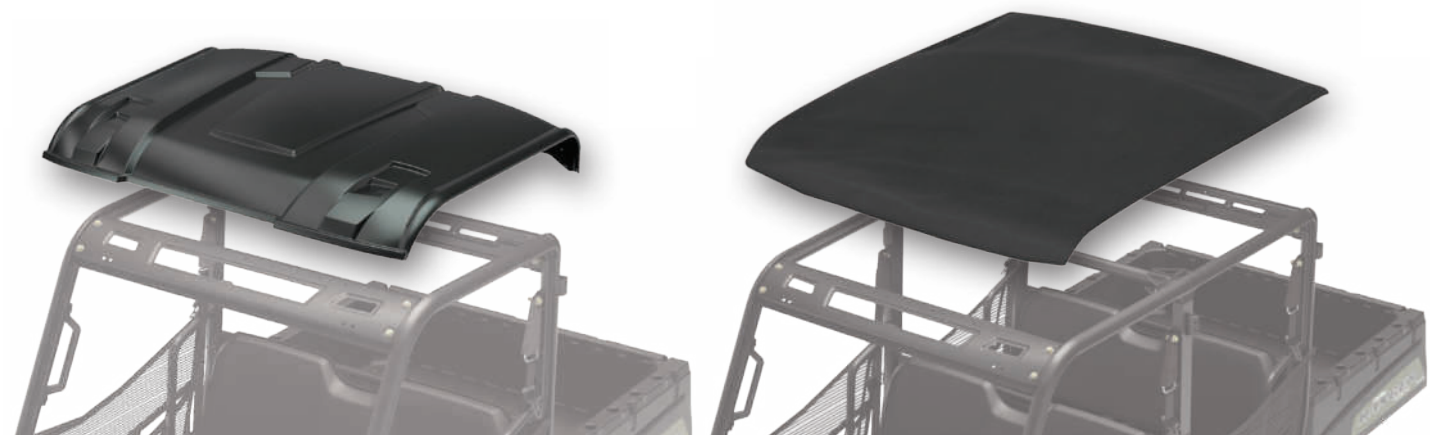

#### SPORT ROOF - POLY



- Provides shade, superior overhead protection
- Tough injection-molded design resists distortion from the elements
- Polaris Pursuit Camo offers effective visual camouflage in the field

- » 2-SEAT BLACK • 2885077  
EV '15-22, 570 '15-21, 500 '17-22
- » CREW BLACK • 2885078  
CREW 570-4 '15-21

# DOORS

- PREMIUM FEATURES**
- UNPRECEDENTED VENTILATION OPTIONS**
- EASY AND FAST INSTALLATION**

POLARIS ENGINEERED ADVANTAGES

	POLY DOORS	CANVAS DOORS
<b>FRONT DOORS (SET OF 2)</b> EV '15-22, CREW 570-4 '15-21, 570 '15-21, 500 '17-22	<b>HINGED WINDOW</b> A premium, door offering hinged window for customizable ventilation in the cab.   Hinged Window - Poly Doors - Black 2882247	<b>ZIP WINDOW</b> Lightweight, durable protection with adjustable zipper ventilation and see-through bottom panel.   TOP SELLER Zip Window Doors - Canvas - Black 2879963
<b>REAR DOORS (SET OF 2)</b> CREW 570-4 '15-21		 Zip Window Doors - Rear - Canvas - Black 2879964





# WINDSHIELDS & REAR PANELS

## GLASS VS POLY

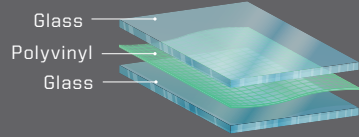

- Superior optical clarity (automotive level)
- Scratch-resistant
- Curved to fit, seals tight
- Cold weather / heavy duty
- Wiper ready (windshield only)

VS

- Lightweight, flexible, easy to store/remove
- Impact-resistant
- Tight seal keeps out rain and dust

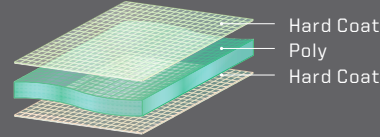

### LOCK & RIDE REVOLUTIONARY INSTALLATION



### AIRTIGHT GASKET SEAL

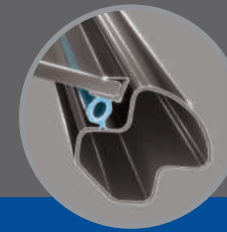

### VENTING OPTIONS

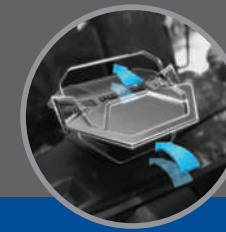

### MULTI-FUNCTION FEATURES



### POLARIS ENGINEERED ADVANTAGES

## WINDSHIELDS



### LOCK & RIDE TIP-OUT WINDSHIELD - GLASS

- Made of strong, optical-grade laminate safety glass
- Provides optimal visibility and the best protection from wind, inclement weather and off-road hazards
- Minimal perimeter framework for a low profile and full visibility
- Tip-out feature adjusts the windshield to an open position to enjoy airflow in the cab

» 2881784  
EV '15-22, CREW 570-4 '15-21, 570 '15-21, 500 '17-22

### FULL WINDSHIELD - GLASS TOP SELLER

- Provides the highest level of scratch resistance

» 2881783  
EV '15-22, CREW 570-4 '15-21, 570 '15-21, 500 '17-22

### LOCK & RIDE FULL WINDSHIELD - POLY TOP SELLER

- Durable, optical-grade, 0.6 cm-thick polycarbonate offers outstanding rider protection and visibility
- Windshield has minimal perimeter framework for full visibility

» 2883318  
EV '15-22, CREW 570-4 '15-21, 570 '15-21, 500 '17-22

### LOCK & RIDE HALF WINDSHIELD - POLY

- Strong, durable polycarbonate half windshield delivers a combination of protection and airflow into the cab
- Half windshield offers protection from rain, sleet, spray, and off-road hazards

» 2883320  
EV '15-22, CREW 570-4 '15-21, 570 '15-21, 500 '17-22



### FLIP-DOWN WINDSHIELD - HARD COAT POLY TOP SELLER

- Two venting options: fully sealed or flip-down/ remove upper half for some protection with maximum ventilation

» 2882178  
EV '15-22, CREW 570-4 '15-21, 570 '15-21, 500 '17-22

### LOCK & RIDE VENTED WINDSHIELD - HARD COAT POLY

- Frameless design for maximum visibility
- Added vents for airflow on a hot day or defrosting on a cold day

» 2883342  
EV '15-22, CREW 570-4 '15-21, 570 '15-21, 500 '17-22

### LOCK & RIDE FULL WINDSHIELD - HARD COAT POLY TOP SELLER

- Durable, optical-grade, 0.6 cm-thick polycarbonate offers outstanding rider protection and visibility
- Windshield has minimal perimeter framework for full visibility

» 2883319  
EV '15-22, CREW 570-4 '15-21, 570 '15-21, 500 '17-22

### LOCK & RIDE REAR PANEL - GLASS TOP SELLER

- Durable, tempered laminate glass provides a high level of scratch resistance

» 2879965  
EV '15-22, CREW 570-4 '15-21, 570 '15-21, 500 '17-22

### LOCK & RIDE REAR PANEL - POLY TOP SELLER

- Strong, 0.6 cm-thick polycarbonate provides outstanding impact and scratch resistance

» 2879812  
EV '15-22, CREW 570-4 '15-21, 570 '15-21, 500 '17-22

**HARD COAT POLY | 30x MORE SCRATCH-RESISTANT**



### REDUCE IN-CAB DUST SWIRL BY ADDING A REAR PANEL

With a windshield and roof installed, turbulent air develops behind the cab. Add a rear panel to reduce dust intrusion from this swirl.



# CAB KITS

PICK YOUR OWN PACKAGE!

## FULL CAB

28K0004

2879990	Busbar Harness	P. 59
2885077	Poly 2-Seat Sport Roof with Lock & Ride Technology	P. 82
2882247	Hinged Window Doors - Poly	P. 83
2881783	Full Windshield - Glass	P. 84
2879965	Rear Panel - Glass	P. 85
2879968	Windshield Wiper & Washer System	P. 88

EV '15-22, 570 '15-21



## HALF CAB

28K0005

2879990	Busbar Harness	P. 59
2885077	Poly 2-Seat Sport Roof with Lock & Ride Technology	P. 82
2881783	Full Windshield - Glass	P. 84
2879812	Rear Panel - Poly	P. 85
2879968	Windshield Wiper & Washer System	P. 88

EV '15-22, 570 '15-21



## ADD TO YOUR CAB COMFORT

WITH THE HEATER SYSTEM

### HEATER KIT

» 2879967  
570 '15-21



# CONVENIENCE & PROTECTION



## STANDARD BRUSHGUARDS

PERFECT FOR: **INCREASED PROTECTION AROUND LIGHTING AND FENDERS**



3.2 cm DIAMETER  
STEEL TUBE CONSTRUCTION

» REAR • 2879972  
EV '15-22, CREW 570-4 '15-21, 570 '15-21, 500 '17-22  
DOES NOT WORK WITH FLIP-DOWN POLY WINDSHIELD 2881919

## CONVENIENCE FEATURES

### CAB SEAL SYSTEM

» 2-SEAT • 2880508  
EV '15-22, CREW 570-4 '15-21, 570 '15-21, 500 '17-22  
(INCLUDED WITH PREMIUM DOORS)

### EPS SYSTEM (ELECTRIC POWER STEERING)

- Enjoy smooth, easy, precise, responsive automotive-quality power steering
- EPS provides a light steering feel in all situations, including low-speed maneuvering through challenging terrain

» 2879970  
CREW 570-4 '15-21, 570 '15-21  
1824163 REQUIRED FOR 2016 AND NEWER 570 MODELS

### HORN

» 2879273  
EV '15-22, CREW 570-4 '15-21, 570 '15-21, 500 '17-22

### AUXILIARY BATTERY KIT

» 2880555  
EV '15-22  
REQUIRED FOR 12V ACCESSORIES ON EV

### REVERSE WARNING ALERT

» 2880631  
CREW 570-4 '15-21, 570 '15-21, 500 '17-22

### SPEEDKEY

» 2879988  
CREW 570-4 '15-21, 570 '15-21

# FIELD TESTED INTERIOR

**ADD SUPERIOR ALL-WEATHER FUNCTIONALITY** and comfort to your RANGER with premium Polaris Engineered Accessories. Keep warm on the coldest of days with a heater kit and improve visibility with a Windshield Wiper and Washer System or Large Rear View Mirror.



### WINDSHIELD WIPER & WASHER SYSTEM

• Use with Full Glass Windshield 2881783 only

» 2879968  
EV '15-22, CREW 570-4 '15-21, 570 '15-21, 500 '17-22  
⚠ Requires Battery Connection Cable



### LARGE REAR VIEW MIRROR TOP SELLER

» 2879969  
EV '15-22, CREW 570-4 '15-21, 570 '15-21, 500 '17-22

# WINCHES

FEATURES	PRO PRO HEAVY DUTY SERIES	HD HEAVY DUTY SERIES	
RAPID ROPE RECOVERY	STANDARD	NOT AVAILABLE	
AUTO STOP TECHNOLOGY	STANDARD	OPTION	
WINCH LINE	SYNTHETIC ROPE	STEEL CABLE	
CONTROL	WIRELESS STANDARD, WIRED OPTION	WIRED STANDARD, WIRELESS OPTION	
MODEL	2,041 kg	1,588 kg	ADD REQUIRED CABLES
570 '15-21 CREW 570-4 '15-21 500 '17-22 EV '19-22 EV REQUIRES AUXILIARY BATTERY KIT 2880555	2882238 	TOP SELLER 2881669 	2-SEAT MODELS: TOP SELLER 2879990 CREW MODELS: 2880929

### UPGRADE YOUR HD WINCH WITH THESE ACCESSORIES

#### WIRELESS REMOTE

- Up to 15 m range with LED indicator
  - Direct plug and play operation
- » 2879316  
Works with 2881669



#### SYNTHETIC ROPE

- 2,041 kg  
» 2879187
- 1,588 KG  
» 2878888



#### AUTO STOP UPGRADE

- Billeted aluminum
  - Replaces stock fairlead
- » 2881693  
Works with 2881669  
SYNTHETIC ROPE REQUIRED

### UPGRADE YOUR CONTROLS HD OR PRO HD WINCHES

#### WIRED REMOTE CONTROL

- Must order remote handle and socket together
- » REMOTE HANDLE 4013466  
» SOCKET 4014228

#### POWER CONTROLLER

- Control your winch and plow hydraulics directly from the shift knob
- » 2879227  
CREW 570-4 '14-21, 570 FULL SIZE '17-22, 570 '14-21, 500 '11-22





# STORAGE



## LOCK & RIDE®

Exclusive and available on all Polaris vehicles, Lock & Ride accessories let you quickly change from one task to another with hundreds of options.

WITH THE FLIP OF A LEVER, LOCK & RIDE PLUNGERS USE OUTWARD PRESSURE TO EXPAND FOR A SECURE FIT.

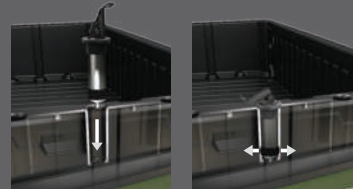

### LOCK & RIDE CARGOMAX SYSTEM

- Comes standard with a support bar that ties the two sides together for a sturdy cargo hold
- Adjustable utility hooks provide more options for hanging tools, cords or gear
- Two sides and a support bar included

» 2882177  
EV '15-22, CREW 570-4 '15-21,  
570 '15-21, 500 '17-22

### LOCK & RIDE STORAGE BOX

- Rugged roto-molded construction locks for security and is water-resistant
- Low-profile design retains additional hauling capacity on top of vault
- Sliding drawer features foam padding and adjustable dividers
- Fits perfectly in the bed of your RANGER, pickup box or full-size SUV

» 2877033  
EV '11-22, CREW 570-4 '14-21, 570 '14-21, 500 '11-22



### LOCK & RIDE TOOL RACK

- Attach on the inside or outside of the cargo bed
- » 2881533  
EV '11-22, CREW 570-4 '14-21, CREW 570 FULL SIZE '18-23,  
570 FULL SIZE '17-23, 570 '14-21, 500 '11-22



### RIDE & REPAIR ESSENTIALS KIT

» 2881207  
EV '11-22, CREW 570-4 '14-21, CREW 570 FULL SIZE '18-23,  
570 FULL SIZE '17-23, 570 '14-21, 500 '11-22



### FIRE EXTINGUISHER HOLDER

- Quick-release strap allows for easy access
- » 2882158  
EV '15-22, CREW 570-4 '15-21, 570 '15-21, 500 '17-22



### LOCK & RIDE D-RINGS TOP SELLER

- The most versatile Lock & Ride accessory - add as many as you need to secure your cargo with bungee cords or straps
- » 2881545  
EV '11-22, CREW 570-4 '14-21, CREW 570 FULL SIZE '18-23,  
570 FULL SIZE '17-23, 570 '14-21, 500 '11-22



### UNDER SEAT STORAGE BOX

» 2880046  
EV '15-22, CREW 570-4 '15-21, 570 '15-21, 500 '17-22



### LOCK & RIDE CHAINSAW MOUNT

» 2879354  
EV '11-22, CREW 570-4 '14-21, CREW 570 FULL SIZE '18-23,  
570 FULL SIZE '17-23, 570 '14-21, 500 '11-22

## STRAPS



### 3.8 cm x 4.6 m 2494.8 kg RATCHET STRAP

- Heavy-duty webbing
  - 2 Pack
- » 2884031



### LOCK & RIDE QUICKSTRAP

- The quickest and most secure way to mount Polaris accessories
  - Sold as a pair
- » 2882187  
ALL COOLERS, RANGER CARGO BOXES



### 5.1 cm x 6.1 m 4535.9 kg RATCHET STRAP

- Heavy-duty webbing
- » 2884032

## DO MORE:



**COOLERS**  
P. 48



**HUNT**  
P. 50

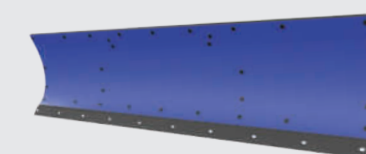

**COLD WEATHER**  
P. 52



**LIGHTING**  
P. 58



# HIT THE TRAILS RANGER 150 EFI ACCESSORIES



## YOUTH CRAWLER TIRE

- Premium durability to ride longer
- Increased ground clearance and performance

150 EFI '18-23

	TREAD DEPTH	TIRE WEIGHT	PLY RATING	SIDEWALL BELTS	LOAD RATING
12" <b>22" x 8" R12</b> 5416945	FRONT/ REAR <b>13 mm</b>	<b>13 kg</b>	<b>6</b>	<b>3</b>	<b>413 kg</b>
12" <b>22" x 10" R12</b> 5416944					



## YOUTH BUCKLE WHEEL

- » FRONT • 12" x 7" • 1524114
- » REAR • 12" x 8" • 1524115

150 EFI '18-23



## PRO ARMOR WHEEL & TIRE KIT: YOUTH CRAWLER & BUCKLE

- » 2885154

150 EFI '18-23



## FULL-WINDSHIELD - POLY

- .32 cm clear poly carbonate
- Mounts with four simple P-clamps

- » 2883288

150 EFI '18-23



## HALF-WINDSHIELD - POLY

- 33 cm tall
- .32 cm clear poly carbonate
- Mounts with four simple P-clamps

- » 2883298

150 EFI '18-23



## FRONT & REAR BRUSHGUARD SET

- Durable, e-coated steel construction
- Front and rear brushguard included

- » 2883287

150 EFI '18-23



## SPORT ROOF - POLY

- Stay protected from rain, snow and sun
- Easily installs

- » 2883289

150 EFI '18-23



# FOR THE LIFE OF YOUR RIDE

**PARTS THAT PUSH THE LIMITS WITHOUT SACRIFICING STRENGTH AND DURABILITY.**

We build our products so anyone with the right tools can maintain their vehicle.

**POLARIS**

**ENGINEERED PARTS & LUBRICANTS**

PARTS & GARAGE

MAINTENANCE

OIL & LUBRICANTS

MAINTENANCE FLUIDS

HO PARTS

SERVICE PARTS

CLEANERS & TRAILERING

## MAINTENANCE TIP

### BREAK-IN PERIOD

The break-in period for your new RANGER is the first 25 hours of operation, or the time it takes to use the first two tanks of fuel. No single action on your part is as important as a proper break-in period. Careful treatment of a new engine will result in more efficient performance and longer life for the engine.

**NOTICE:** Excessive heat build-up during the first three hours of operation will damage close-fitted engine parts. Do not operate at full throttle or high speeds for extended periods during the first three hours of use.

### AIR FILTER

A clogged air filter can restrict air flow to the engine leading to reduced engine performance, engine life or catastrophic failure.

### BRAKE PADS

Maintaining and/or replacing brakes are critical to the safety and functionality of a vehicle. Brake pads should be checked for wear and oil or grease (petroleum products) contamination and brake discs should be checked for cracks, excessive corrosion or warping.

### HALF SHAFT

Check for tears and punctures in the boot, which can lead to CV joint wear that can contribute to axle failure.

### BATTERY

To ensure a battery maintains its level of charge when unused for extended periods of time or during freezing weather, the battery should be connected to a suitable Battery Charger. Be sure to check for corrosion from the terminals to the ends of the cables.

### DRIVE BELT

Polaris Engineered belts deliver unmatched performance for your off-road vehicle. Developed and tested on all our engines for all environments and conditions. Check your belt for delamination, hour glassing and glazing.

#### BREAK-IN PERIOD

- Use lower gear (if available) while varying speeds and avoid wide open throttle for 8-16 km
- If no low gear is available, vary at moderate speeds while avoiding wide open throttle for 80 km

#### OUR INVESTMENT

- 64,00+ km of field testing
- Thousands of dyno hours
- 18+ months of development (13,000+ design hours) per belt
- 1,500+ vehicle validation hours
- Collaboration with powertrain and clutch engineers

#### YOUR ADVANTAGE

- No clutch recalibration
- Less wear and tear due to heat
- Ensure maximum vehicle performance
- More time riding, less time wrenching
- Produced in collaboration with powertrain and clutch engineers to ensure a perfect fit, maximum performance and ultimate durability

### OIL FILTER

Change oil filters with every oil change to provide the best engine protection and keep the engine operating at peak performance.

**FOLLOW RECOMMENDED SERVICE INTERVALS IN THE OWNER'S MANUAL**

## MAINTENANCE SCHEDULE

25 HRS / 400 km

### BREAK-IN MAINTENANCE

**ENGINE OIL & OIL FILTER:**  
CHANGE

**GENERAL LUBRICATION:**  
ALL FITTINGS, PIVOTS, CABLES, ETC.

**AIR FILTER:**  
INSPECT & REPLACE AS NEEDED

**EXHAUST SYSTEM:**  
INSPECT & CLEAN  
INSPECT FOR LEAKAGE OR CARBON BUILD UP AT JOINTS  
INSPECT & CLEAN SCREEN TYPE SPARK ARRESTOR

50 HRS / 800 km

### 6 MONTHS

**EXHAUST SYSTEM:**  
INSPECT & CLEAN  
INSPECT FOR LEAKAGE OR CARBON BUILD UP AT JOINTS

INSPECT & CLEAN SCREEN TYPE SPARK ARRESTOR

**GENERAL LUBRICATION:**  
ALL FITTINGS, PIVOTS, CABLES, ETC.

100 HRS / 1,600 km

### 12 MONTHS

**ENGINE OIL & OIL FILTER:**  
CHANGE

**DRIVE BELT:**  
INSPECT & ADJUST  
REPLACE AS NEEDED

**TRANSMISSION FLUID:**  
CHANGE

**FRONT DRIVE FLUID:**  
CHANGE

**DRIVE BELT:**  
INSPECT & ADJUST  
REPLACE AS NEEDED

**EXHAUST SYSTEM:**  
INSPECT & CLEAN  
INSPECT FOR LEAKAGE OR CARBON BUILD UP AT JOINTS

INSPECT & CLEAN SCREEN TYPE SPARK ARRESTOR

150 HRS / 2,400 km

### 18 MONTHS

**ENGINE OIL & OIL FILTER:**  
CHANGE

**BATTERY:**  
TEST, CLEAN & REPLACE AS NEEDED

**DRIVE BELT:**  
INSPECT & ADJUST  
REPLACE AS NEEDED

**TIRES:**  
INSPECT CONDITION & PRESSURE

**EXHAUST SYSTEM:**  
INSPECT & CLEAN  
INSPECT FOR LEAKAGE OR CARBON BUILD UP AT JOINTS

INSPECT & CLEAN SCREEN TYPE SPARK ARRESTOR

200 HRS / 3,200 km

### 24 MONTHS

**ENGINE OIL & OIL FILTER:**  
CHANGE

**BRAKE PADS & FLUID:**  
INSPECT & CLEAN  
REPLACE AS NEEDED

**SPARK PLUGS:**  
INSPECT  
REPLACE AS NEEDED

**EXHAUST SYSTEM:**  
INSPECT & CLEAN  
INSPECT FOR LEAKAGE OR CARBON BUILD UP AT JOINTS

INSPECT & CLEAN SCREEN TYPE SPARK ARRESTOR

250 HRS / 4,023 km

### 30 MONTHS

**ENGINE OIL & OIL FILTER:**  
CHANGE

**BATTERY:**  
TEST, CLEAN & CHECK FLUID LEVEL  
REPLACE AS NEEDED

**DRIVE BELT:**  
INSPECT & ADJUST  
REPLACE AS NEEDED

**GENERAL LUBRICATION:**  
ALL FITTINGS, PIVOTS, CABLES, ETC.

**EXHAUST SYSTEM:**  
INSPECT & CLEAN  
INSPECT FOR LEAKAGE OR CARBON BUILD UP AT JOINTS

INSPECT & CLEAN SCREEN TYPE SPARK ARRESTOR

300 HRS / 4,828 km

### 36 MONTHS

**ENGINE OIL & OIL FILTER:**  
CHANGE

**AIR FILTER:**  
INSPECT & REPLACE AS NEEDED

**GEARCASES:**  
CHECK OIL LEVEL

**EXHAUST SYSTEM:**  
INSPECT & CLEAN  
INSPECT FOR LEAKAGE OR CARBON BUILD UP AT JOINTS

INSPECT & CLEAN SCREEN TYPE SPARK ARRESTOR

**CHECK YOUR OWNER'S MANUAL FOR ADDITIONAL RECOMMENDED SERVICE ITEMS AND VEHICLE-SPECIFIC TIMING**



# OIL

## PS-4 FORMULATIONS BEST PROTECTION, BEST PERFORMANCE

Our new PS-4 5W-50 formulation and PS-4 Extreme Synthetic 0W-50 have been designed to provide the best fluid technologies for long lasting wear protection. These formulations include a new Polaris exclusive additive system to keep the engine cleaner from deposit build-up to maximize power and powersports-grade synthetic base stocks that provide the ultimate in engine protection.

### PS-4 5W-50 FULL-SYNTHETIC OIL

Optimal for ambient operating temperatures of -40° C to 38° C

» 1L 502484	» 25L 502486	» 200L 502488
» 4L 502485	» 60L 502487	

### PS-4 0W-50 EXTREME FULL-SYNTHETIC OIL

Optimal for ambient operating temperatures of -43° C to 54° C

» 1L 503220	» 25L 503233	» 200L 503235
» 4L 503221	» 60L 503236	

### POLARIS DIESEL HD

Synthetic performance oil, especially designed for work applications.

» 1L 502573	» 25L 502575	» 200L 502577
» 4L 502574	» 60L 502576	

## OIL CHANGE KITS

These convenient kits include everything needed including filter and oil volume per vehicle

PART NUMBER	VEHICLE FITMENT
502541	SINGLE 570, TWIN 600, TWIN 700, TWIN 800
502543	RANGER/RZR 900/1000
502542	SPORTSMAN 550/850/1000

**12+ DEDICATED  
TEAM MEMBERS**

FOCUSED ON  
POLARIS OIL

**18+  
MONTHS**

DEVELOPMENT  
& TESTING

**76,000+  
HOURS**

DYNO  
TESTING

**3.5 MILLION+  
KILOMETERS**

FIELD  
TESTING

POLARIS INVESTS IN EACH OIL  
AT AND ABOVE THESE LEVELS

### ENGINE WEAR TEST LOWER NUMBER = LESS WEAR OF CRITICAL ENGINE PARTS LESS WEAR MEANS LONGER ENGINE LIFE

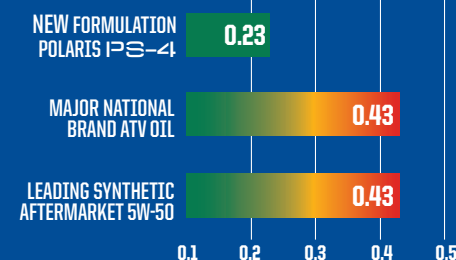

ASTM D4172. In 3rd party against 11 competitive products Polaris had 40% or better wear protection compared to all of the test products.

#### THE BEST PROTECTION

- At least 40% improved wear protection compared to previous Polaris PS-4 formulation and all aftermarket oils tested

Best engine protection against wear for the longest engine life.

### DEPOSIT TEST LOWER DEPOSITS = MAXIMUM POWER

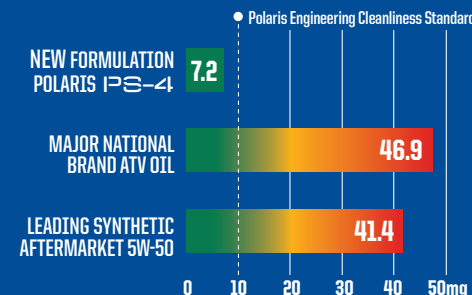

ASTM D6335. In 3rd party against 9 competitive products Polaris PS-4 had less than half the deposits compared to the next closest product. No other tested products met Polaris Engineering standards for deposit cleanliness.

#### MAXIMUM PERFORMANCE

- New improved PS-4 formulation provides 33% less deposits than previous PS-4 formula
- At least 50% less deposits than all aftermarket oils tested

The cleanest engine for maximum power and performance!

## POLARIS EXTREME SYNTHETICS

Our new PS-4 Extreme Synthetic 0W-50 formulation applies only to the **absolute highest performance** products we sell, for ultimate protection and performance in the most extreme conditions.



- Our best extreme high temp formulation, excellent for severe high temperatures and for racing, even at temps over 54°C.
- Provides easier starting and cold temperature protection, even to extreme cold temps of below -42°C.
- Latest in premium synthetic PAO and Ester base stocks along with careful balance of moly and ZDDP additives for ultimate long lasting wear protection.

• Polaris exclusive clean engine additive system reduces deposits and carbon build-up for peak performance and power.





# MAINTENANCE FLUIDS



## ENGINE OIL

Maximum protection for your 4-cycle engine.  
NOT COMPATIBLE WITH XP KINETIC

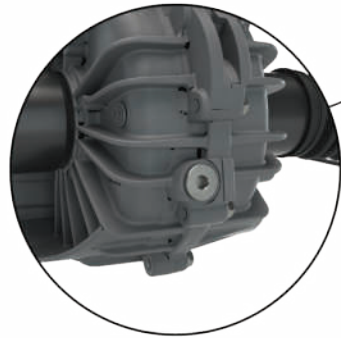

## AGL

Protect gears, drive chain and bearings from scoring and wear.

- » 1 L • 502505
- » 25 L • 502507
- » 200 L • 502508

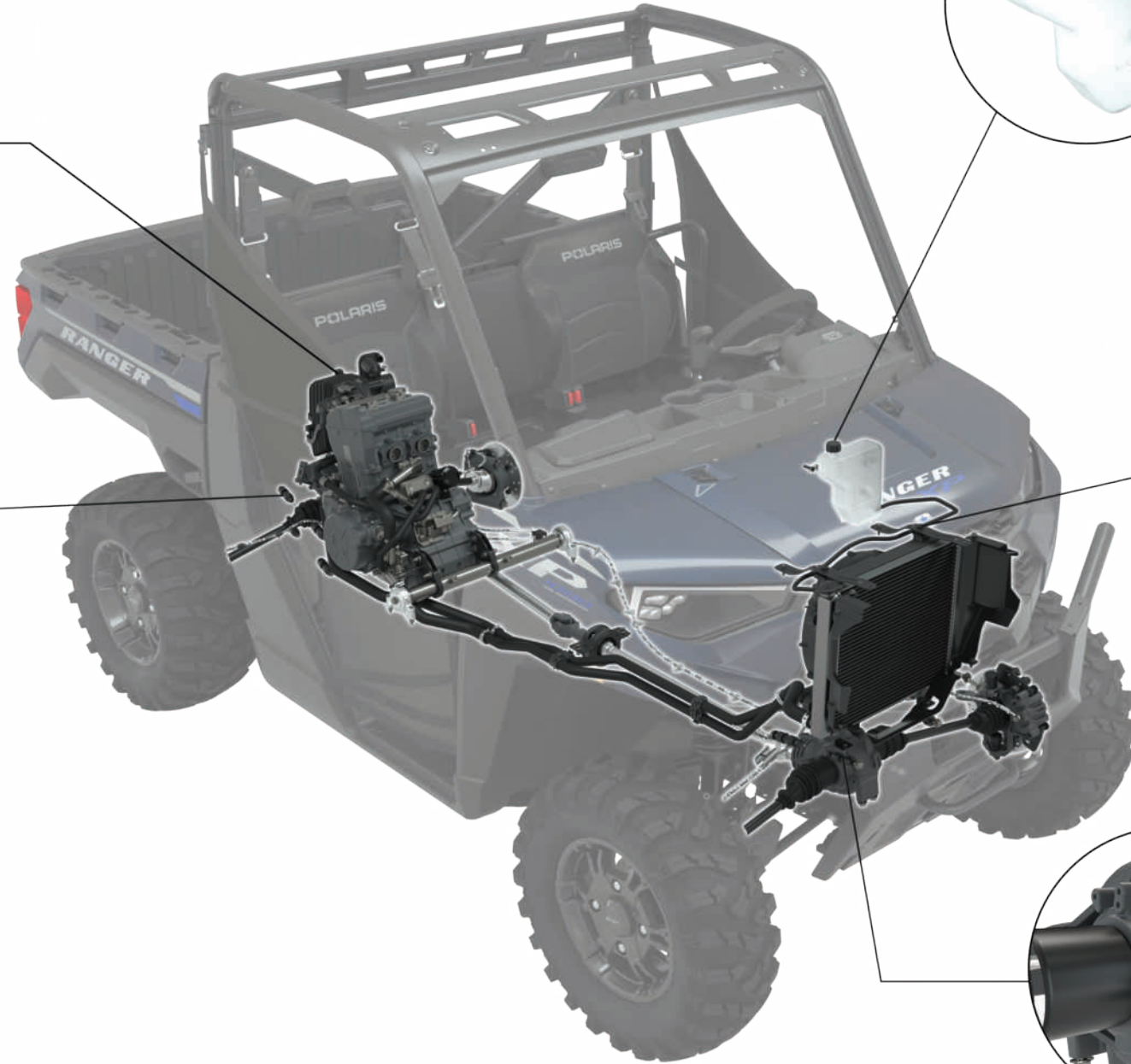

## ANTI-FREEZE

Prevent corrosion on metal components, eliminate scaling and maximize cooling system performance.

- » 1 L • 502566
- » 25 L • 502567
- » 206 L • 502568

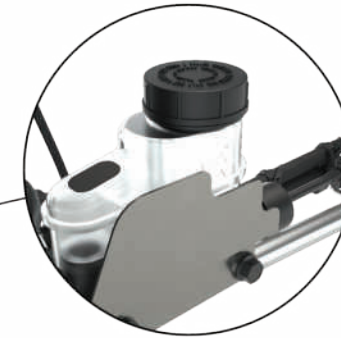

## DOT 4 BRAKE FLUID

A high-quality brake fluid designed for use in Polaris hydraulic brakes.

- » 250 ML • 502526



## DEMAND DRIVE FLUID

Provide positive 4WD engagement in extreme cold or high heat conditions and protect internal components under heavy loads.

- » 1 L • 502563
- » 25 L • 502564
- » 200 L • 502565



## PREMIUM GAS SHOCK OIL

- » 1 L • 502518



## ALL-SEASON GREASE TUBE

- Specialized water-resistant lubricant
- » 400 g • 502538



## ANGLE DRIVE FLUID

• Extreme pressure, anti-wear and high viscosity film lubrication for maximum protection

- » 1 L • 502510
  - » 25 L • 502511
  - » 202 L • 502512
- SPORTSMAN, RANGER, RZR  
ANGLE DRIVE GEAR  
CASE SYSTEMS



## CARBON CLEAN

- Ultimate fuel and injection system cleaner
- » 125 mL • 502528



## FUEL STABILIZER

- Fuel Stabilizer prevents ethanol corrosion and stabilizes fuel for up to 2 years. Dual-antioxidant formula protects against gum and varnish for easy starting.
- » 125 mL • 502519



# HD HEAVY DUTY PARTS

All Polaris parts are developed and tested to help you get the most out of your ride. We're taking the passion of our riders, workers and outdoor enthusiasts to the next level with HD Parts.

Engineered and designed for:

- Greater durability
- Enhanced performance
- Greater wear and tear capabilities
- All weather conditions



## DRIVE BELTS

The enhanced rubber material compound in these belts keep them cool in extreme heat, while our patented cord treatment process maximizes the transfer of horsepower to the ground for those customers hauling heavy loads.

OE	HD HEAVY DUTY PARTS
3211149	
3211169	3212326
3211196	
3211113	3212328



## BUSHINGS

The advanced material compound of the bushings enables tighter tolerances to reduce overall wear on the system, while the superior triple lip sealing prevents intrusion of the elements.

LOCATION	OE	HD HEAVY DUTY PARTS
FRONT UPPER BUSHINGS	5439874	1543367
	5439730	
	5439270	
FRONT LOWER BUSHINGS	5439874	1543367
	5439730	
	5439270	
REAR UPPER BUSHINGS	5439874	1543367
	5439730	
	5439270	

LOCATION	OE	HD HEAVY DUTY PARTS
REAR LOWER BUSHINGS	5439874	1543367
	5439730	
	5439270	
UPPER HUB BUSHINGS	5439270	1543326
	5439270	
LOWER HUB BUSHINGS	5439270	1543326

## OIL FILTERS

The advanced synthetic material built into these filters offers the highest debris holding capacity, maintains oil flow and maximizes performance.

OE	HD HEAVY DUTY PARTS
2540086	2522485



## WHEEL BEARINGS

Fully sealed for added protection against intrusions. Made of a higher grade steel for extended life in extreme conditions.

LOCATION	OE	HD HEAVY DUTY PARTS
FRONT WHEEL BEARINGS	3514924	3515090
	3514634	3515088
REAR WHEEL BEARINGS	3514924	3515090
	3514917	3515087
	3514635	3515087



## NEW BATTERY\*

AGM fully sealed for optimal starting power with maximum reserve capacity, designed for highly accessorized vehicles and extreme operating conditions.

OE	HD HEAVY DUTY PARTS
4014132	4081481



## WHEELS & TIRES

Class leading durability for off-road performance and traction for confident driving in extreme conditions.

- » 1524022-458 • HD WHEEL - 14x7\*
- » 5417507 • PRO ARMOR HD-K - 29x10R14\*
- » 5457498-458 • HD WHEEL CENTER CAP\*
- » 5415756 • PRO ARMOR XD-K FRONT
- » 5415757 • PRO ARMOR XD-K REAR

\* SHOWN



## BUSHING KITS

Easily update the entire front and rear suspension.

- » 2830560  
XP 900 '13-'19, XP 900 CREW '14-'19, XP 1000 '17, XP 1000 CREW '17, 570 FULL SIZE '15-'20, 570 FULL SIZE CREW '15-'20
- » 2830561 (shown)  
570 EFI '14-'20, 570 EFI CREW '14-'20

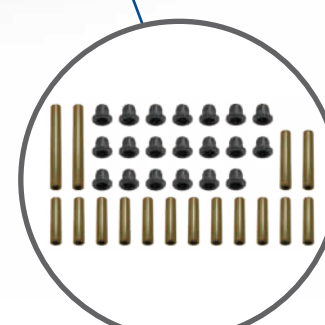

## NEW DRIVE SHAFTS\*

Designed for all around heavy-duty applications, the complete axle shaft assembly provides enhanced joint strength and includes TPE inner and outer boots which provide maximum puncture and tear resistance.

LOCATION	OE	HD HEAVY DUTY PARTS
FRONT	1334351	1337241
	1332637	1337242
	1336966	1337243
REAR	1333748	1337239
	1334361	1337240



## BRAKE PADS

Engineered to provide longer life and better stopping power while riding in extreme conditions.

OE	HD HEAVY DUTY PARTS
2205949	2208933
2202413	2208934
2203318	2208936

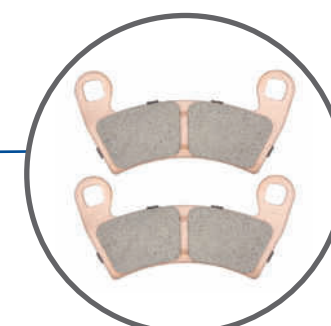

## NEW CV BOOT KIT

TPE rubber compound for maximum puncture and tear resistance, includes (1) boot, grease and clamp to replace OE stock part. Provides increased durability for riding in extreme conditions.

OE	HD HEAVY DUTY PARTS
2204102	2209922
3236165	2209923

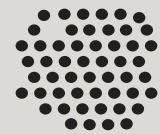

SAND



MUD



WATER



EXTREME COLD



EXTREME HEAT UP TO 54° C



HEAVY PAYLOADS



EXTENDED LIFE

PARTS & GARAGE

MAINTENANCE

OIL & LUBRICANTS

MAINTENANCE FLUIDS

HD PARTS

SERVICE PARTS

CLEANERS & TRAILERING



# SERVICE PARTS

Polaris Engineered service parts deliver unmatched performance and fit for your off-road vehicle.

All service parts are engineered specifically for your machine. Which means everything is designed, tested and perfected to maximize the life of your ride. Getting Polaris Engineered parts is a decision that pays off in the long run, because it ensures there is a long run.

 **PARTS FINDER** VISIT YOUR POLARIS DEALER TO SHOP FOR SERVICE PARTS.

OVER  
100,000  
PARTS  
AVAILABLE!



## FOR THE LIFE OF YOUR RIDE

Maintenance is the key to keeping your Polaris off-road vehicle performing at its peak. Items like belts, lubricants, and batteries represent only a few of these critical items engineered specifically by Polaris.



## POLARIS ENGINEERED DRIVE BELTS

### TESTED, PERFECTED

We test each belt on the intended vehicle – we don't just try to make an existing belt "just work".  
– Amery Kuhl, Polaris CVT System Engineer

#### OUR INVESTMENT

- 32,187 km of field testing
- Thousands of dyno hours
- 18+ months of development (3,000+ design hours) per belt
- 1,200+ vehicle validation hours
- Collaboration with powertrain & clutch engineers

#### YOUR ADVANTAGE

- No clutch recalibration
- Less wear & tear due to heat
- Ensure maximum performance of your vehicle
- More time out riding, less time wrenching

**OUR INVESTMENTS ENSURE POLARIS BELTS  
OUTPERFORM YOUR EXPECTATIONS.**



# CV BOOT REPAIR KIT\*

FIX ON THE GO | TEMPORARY COVERAGE

- A quick trail-side fix to increase trail time
- The flexible and durable boot material expands over a cone tool for CV boot repairs, without disassembling CV axles
- Universal fit – works as a temporary fix for most powersports axles
- All components fit inside the cone, and a cover is provided for compact durable storage
- Easily fits in a cargo box, attached to the roll cage, in the glovebox or many other storage locations



Items shown are contained inside cone

## UTV CV BOOT REPAIR KIT

Kit includes the following items:

- (1) Expandable XL CV Boot
- (1) Reusable Cone Tool
- (2) CV Boot Clamps
- (1) Tube of Silicone Lube
- (1) Grease Packet
- (1) Cone Cover

» 2830526

## UTV TRAIL BOOT ONLY

» 2830527

## ATV

- » CV REPAIR KIT 2830528
- » TRAIL BOOT ONLY 2830529

## HOW TO INSTALL

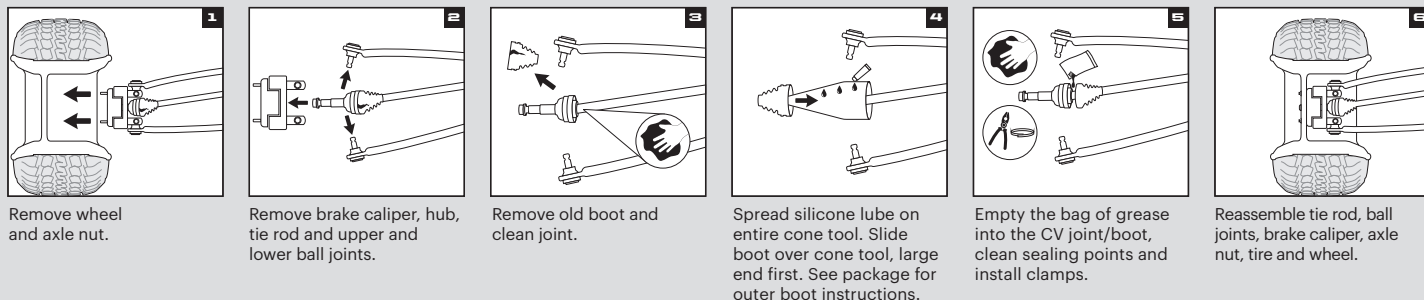

1 Remove wheel and axle nut.

2 Remove brake caliper, hub, tie rod and upper and lower ball joints.

3 Remove old boot and clean joint.

4 Spread silicone lube on entire cone tool. Slide boot over cone tool, large end first. See package for outer boot instructions.

5 Empty the bag of grease into the CV joint/boot, clean sealing points and install clamps.

6 Reassemble tie rod, ball joints, brake caliper, axle nut, tire and wheel.

Refer to your service manual for further instructions and torque specifications.  
\*Designed for temporary CV boot repair. Purchase the OEM CV Boot for a permanent repair.

# KEEP IT CLEAN

## CLEAN

### ALL-PURPOSE CLEANER

- Professional cleaner, which is formulated with a low pH-value. The product spreads well on surfaces and adheres on them for effective cleaning action. Perfectly compatible with rubber, plastic and painted surfaces. The formulation is biodegradable.

» 500 mL • 502309

## SHINE

### INSTANT SHINE & DETAILER

- The INSTANT SHINE AND DETAILER is developed for cleaning action without water. Removes insects, dust and dirt with almost no effort. Applicable for plastics, visors, windscreens, paint and metal. The wipe and shine formulation makes surfaces shine, works water repellent and also has an antistatic effect. Perfect for customers living in urban areas with no access to water, for bike trips or showroom bikes.

» 500 mL • 502303



## TRAILERING



### CALIBER RAMP PRO

- Designed for ATVs and UTVs up to 127 cm wide
  - Integrated grip glides for ultimate traction
  - Folding sides for easy transportation and storing
- » 132 cm x 229 cm • 2884576



### ALUMINUM ARCHED LOADING RAMPS

- Capacity for up to 1,361 kg
- » 193 cm x 30.5 cm • 907 kg • 2875384  
» 224 cm x 30.5 cm • 1,361 kg • 2875386



### LIGHTWEIGHT TRI-FOLD RAMPS

- Ramp folds up for transport
  - Capacity for up to 680.7 kg
  - Safety straps included
- » 183 cm x 130 cm • 2875385  
» 208 cm x 130 cm • 2875860



### FOLDING ALUMINUM ARCHED RAMPS

- Ramp folds up for transport
  - Up to 680 kg total capacity, 340 kg per individual ramp
  - Safety straps included
- » 224 cm x 30.5 cm • 2875387

## HITCHES

### 3:1 HITCHES VERSATILE 3 IN 1 FUNCTIONALITY

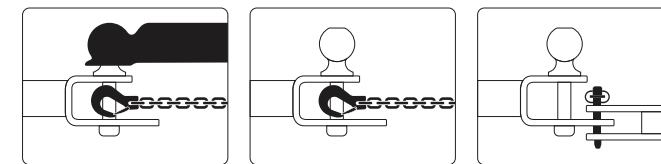

- Ball, hook and pin design
- Durable, rust resistant steel with black powdercoated finish
- Removable ball
- HD 1.6 cm pin and clip



### HITCH WITH 5 cm BALL

- » 5 cm x 5 cm RECEIVER 2830522
- » 3 cm x 3 cm RECEIVER 2830523



### 5 cm HITCH BALL MOUNT

- » 5 cm RECEIVER TONGUE 2875320



### 4.8 cm BALL

- 4.8 cm replacement ball for hitch
  - Designed to work with 3:1 Hitch
- » 2830524



### TRAILER BALL 1.9 cm SHANK

- » 5 cm BALL • 2877603
- » 4.8 cm BALL • 2877602

## STRAPS & ROPES



### RECOVERY STRAP

- 5 cm x 9.1 m
  - 8,165 kg maximum load, 4,082 kg maximum vehicle weight
  - Built in strap wrap - easy storage
  - Loops sewn in to webbing
  - 1 Strap bag
- » 2884033



### RATCHET STRAP

- 3.8 cm x 4.6 m straps, 2 Pack
  - Heavy duty webbing
  - 2,495 kg maximum load, 831 kg working load
  - 2 Pack
- » 2884031



### RATCHET STRAP

- 5 cm x 6.1 m Ratchet Straps with heavy duty webbing
  - 4,536 kg maximum load, 1,497 kg working load
  - Floating D-Rings
  - Double J-Hooks
- » 2884032



### SHOCK STRAPS

- 3.8 cm 1,361 kg breaking strength
  - Keeps tension on tie-down straps to secure load
  - 2 Pack
- » 2883296 • 3.8 cm x 4.5 m  
» 2883295 • 3.8 cm x 2 m

## COVERS

### 2-SEAT & CREW TRAILERING COVERS

- » 2880632 • 570/500/EV EV '15-21, 570 '15-23, 500 '17-22
- » 2880633 • 570 CREW CREW 570-4 '15-23



### 3-SEAT & CREW TRAILERING COVERS

- » 2883419 • XP 1000 XP 1000 '15-23, 1000 '20-23
- » 2883840 • CREW XP 1000/DIESEL XP 1000 '18-23, CREW XP 1000 '17-23, CREW 1000 '20-23
- » 2882160 • POLARIS PURSUIT CAMO SxS FIELD COVER XP 1000 '14-23, EV '11-23, 570 FULL-SIZE '17-23, 570 '14-23, 500 '11-23, 1000 '20-23





**NEW**  
HELMET

- Polycarbonate shell
- Removable & washable lining
- Double lens system with integrated sun visor

- Quick release micrometric adjustment system
- Weight: 1450 g (+/-50 g)

- 1 shell and 2 EPS: XS-M, L-XXL
- ECE 22-06 approved



White Gloss | XS-2XL | 2802311  
Dark Gray Matte | XS-2XL | 2802312



**NEW**  
TECHNICAL JACKET

- Water-resistant jacket
- Ultra-light thanks to polyester ripstop and softshell for optimal comfort
- Ventilated lining
- Hydration hose outlet
- Zip ventilation system on body and back

Black | S-3XL | 2802301



**NEW**  
TECHNICAL PANTS

- Water-resistant pants
- Ultra-light thanks to polyester ripstop, softshell and 1000-D Cordura stretch fabric on the back for optimal comfort
- 2 cargo type pockets
- Zip ventilation system
- Zip and Velcro® adjustment at the bottom of the pants

Black | S-3XL | 2802302



RAIN JACKET

- Polyester ripstop high tearing resistance
- PU coating 1000 mm
- Mesh lining
- Non-removable hood

Black | S-3XL | 2802005



**NEW**  
BOOTS

- Waterproof and breathable lining
- Full-grain oil treated leather upper
- Specific ATV double density compound rubber sole
- Adjustable Velcro® closure

- Replaceable/adjustable plastic buckles
- Anti-bacterial replaceable footbed
- CE-approved motorcycle boots EN 13634:2017

Black | EU39-47 | 2802313  
Brown | EU39-47 | 2802314



TECHNICAL SHIRT

- 100% polyester
- Indelible sublimated graphics
- Hemmed edging
- Lycra cuffs and collar

Black | S-3XL | 2802104



**NEW**  
PUFFY JACKET

- Top body and shoulder polyester woven 3000mm/3000gr + welded quilting
- Lower body nylon 380T downproof
- 80gr padding
- Inner elastic bottom tightening
- Two external pockets with easy-grab puller

Black | S-3XL | 2802303



**NEW**  
PADDED JACKET

- Shoulder and hood softshell waterproof and breathable 3000 mm / 3000 gr
- Lower body and sleeve, polyester woven waterproof and breathable 3000 mm / 3000 gr
- Quilted lining with 80 gr padding
- Elasticized lower body tightening
- Two external pockets with easy-grab puller

Black | S-3XL | 2802306



**NEW**  
RACING PARKA

- Waterproof and breathable 3000 mm / 3000 gr
- Quilted lining with 80 gr padding
- 2 upper body outer pockets and 2 bottom cargo pockets
- Sleeve pocket with lazer holes
- +TPU welded film on zipper

Black | S-3XL | 2802307



**SAFETY GLOVES TOUCH**

- CE-approved motorcycle glove EN 13594:2015
- Touch screen compatible
- Silicon print on fingers to improve grip
- Neoprene cuff with Velcro® tightening
- Reinforcements patches for safety and comfort

NEW Khaki | S-3XL | 2802309  
Black | XS-7,3XL-13 | 2802103

**NEW**  
NEO GLOVES

- CE-approved motorcycle glove EN 13594:2015
- 100% synthetic neoprene glove
- Touch screen compatible
- Knuckle protected
- Reinforcements patches for safety and comfort

Black | XS-7,3XL-13 | 2802310



**SF TECH GLOVES TOUCH**

- CE-approved motorcycle glove EN 13594:2015
- Touch screen compatible
- Knuckle-protected
- Silicon print on fingers to improve grip
- Neoprene cuff with Velcro® tightening
- Reinforcements patches for safety and comfort

NEW Khaki | S-3XL | 2802308  
Black | XS-7,3XL-13 | 2802102



BODYWARMER

- Upper body and side panels in softshell waterproof and breathable 3000mm/3000g
- Lower body nylon downproof
- Padding 80 g
- Two external pockets with easy-grab puller

NEW Khaki | S-3XL | 2802304  
Black | S-3XL | 2802101



RACING SOFTSHELL

- Softshell waterproof and breathable 3000mm/3000g
- Removable hood
- Four external pockets with easy-grab puller

NEW Khaki | S-3XL | 2802305  
Black | S-3XL | 2802003



HYBRID JACKET

- Sleeves in softshell waterproof and breathable 3000mm/3000g
- Body nylon downproof
- Padding 80 g
- Three external pockets with easy-grab puller

Black | S-3XL | 2802004





## OFF-ROAD RIDING JERSEYS

Mesh ventilated panels for maximum airflow  
Elastic sleeves with non-restrictive cuffs



### BLACK

JERSEY | S-3XL | 2862718  
GLOVES | S-3XL | 2862726  
YOUTH JERSEY | S-XL | 2862723

### ORANGE

JERSEY | S-3XL | 2862719  
GLOVES | S-3XL | 2862729

### TEAL

JERSEY | S-3XL | 2862720  
GLOVES | S-3XL | 2862727  
YOUTH JERSEY | S-XL | 2862724

### GREEN

JERSEY | S-3XL | 2862721  
GLOVES | S-3XL | 2862730

### BLUE

JERSEY | S-3XL | 2862722  
GLOVES | S-3XL | 2862728  
YOUTH JERSEY | S-XL | 2862725

## OFF-ROAD RIDING GLOVES

Adjustable wrist closure for a custom fit  
Silicon finger grips and neoprene knuckle protection  
Gloves are not CE-approved

# HEATED APPAREL

Keep warm even on the coldest days with Polaris Heated Apparel. By keeping the heat close to your body, you can stay out for a longer, more comfortable ride. The Polaris Heated Apparel lineup includes the Heated Vest, Heated Base Layers and a Heated Glove Liner for both men and women. Easily control your heat setting with the touch of a button.



**WOMEN'S**  
Black | S-3XL | 2833036

**MEN'S**  
Black | S-3XL | 2833022



Black | S-3XL | 2833044

## HEATED VESTS

WARMTH WITH THE TOUCH OF A BUTTON

- Perfect for any outdoor activity
- Down-proof machine washable material with 160g of insulation for warmth with or without the heater turned on
- Powered by a small rechargeable battery (included) that can also be used to charge a cellphone; battery not machine washable, remove prior to washing
- Easily adjust between four heat settings for changing weather conditions with built-in buttons

## HEATED GLOVE LINER

KEEP YOUR HANDS WARM ON FROSTY DAYS

- Designed to fit under all Polaris riding gloves for an extra layer of warmth to keep you out riding longer
- Easily adjust your heat level by pressing a button on the bottom part of the glove



**WOMEN'S**  
Top | S-3XL | 2833033  
Bottom | S-3XL | 2833034

**MEN'S**  
Top | S-3XL | 2833031  
Bottom | S-3XL | 2833032

## HEATED BASE LAYERS

ADJUSTABLE HEAT CLOSE TO YOUR BODY, MAXIMUM COMFORT IN CHANGING CONDITIONS

- Intended for use as a base layer
- Features lightweight, moisture-wicking fabric to give you the most comfortable layering to wear on all of your cold weather adventures, on or off the trail
- Includes multiple heat panels for evenly distributed heat for maximum warmth and comfort
- Powered by a small rechargeable battery (included) that can be used to charge a cellphone; battery not machine washable, remove prior to washing
- Easily adjust between four heat settings for changing weather conditions with built-in buttons



# ALTITUDE

## 509 ALTITUDE 2.0 HELMET

LIGHTWEIGHT DESIGN, PERFORMANCE-INFUSED STYLE AND GOPRO MOUNTING CAPABILITY

### SHELL

- Thermoplastic poly alloy outer shell

### WEIGHT

- Composite as low as 1,200g
- Carbon fiber as low as 1,150g

### FEATURES

- Strong, lightweight construction of carbon fiber or composite
- Superior fit for all-day comfort
- Pro Series breath box for complete protection, removable for optimal air flow
- One-piece eyepoint creates draft-free seal with 509 goggles
- Magnetic Fidlock® chin-strap technology and integrated GOPRO® mount
- DOT- and ECE 22.05-approved

FIDLOCK®

FOR POLARIS

NEW  
RED  
XS-4XL  
2833054



NEW  
RADIANT GREEN  
XS-4XL  
2833051



BLACK  
XS-4XL  
2861469



CARBON FIBER  
BLACK/LIME  
XS-4XL  
2861473



NEW  
BLUE  
XS-2XL  
2833143



NEW  
RADIANT GREEN  
XS-2XL  
2833142



BLACK  
XS-2XL  
2861557



BLACK/GRAY  
XS-2XL  
2861558



BLACK/LIME  
XS-2XL  
2861559



WHITE/RED  
XS-2XL  
2861561



PINK  
XS-2XL  
2861562

# TENACITY

## TENACITY 4.0 HELMET

COMBINATION OF MODERN STYLE AND PREMIUM PROTECTION WITH INCREDIBLE VALUE

### SHELL

- Shock-resistant, injection-molded thermoplastic

### WEIGHT

- 1,500g

### FEATURES

- Through-flow, full-helmet ventilation
- ProClip quick release chin strap allows you to fasten the chin strap in seconds
- Removable breath box and removable, washable liner
- Tool-less adjustable roost shield
- DOT- and ECE 22.05-approved

# TACTICAL

## TACTICAL 2.0 HELMET

COMBINES STYLE WITH VERSATILITY FOR ULTIMATE COMFORT AND CONTROL

### SHELL

- Shock-resistant, injection-molded thermoplastic

### FEATURES

- Innovative Venturi Vent pulls moist air from helmet without cold wind coming in
- Eyepoint seal is co-integrated with the removable breath box and creates a draft-free seal with 509 goggles and a clear field of view
- Magnetic Fidlock® chin-strap technology
- DOT- and ECE 22.06-approved

FIDLOCK®

FOR POLARIS

NEW  
PINK  
XS-4XL  
2833050



MATTE BLACK  
XS-4XL  
2862468



GRAY  
XS-4XL  
2862469



RED/BLACK  
XS-4XL  
2862467



ORANGE  
XS-4XL  
2862471

# GOGGLES



ORANGE  
2862561

LIME  
2862559

## 509 KINGPIN OFF-ROAD GOGGLE

PREMIUM MATERIALS, ATTRACTIVE PRICE



### FEATURES

- Oversized spherical lens delivers optimal peripheral vision
- Metal tear-off posts provide strength and durability
- Quick-change technology allows you to run the best lens tint for conditions



BLUE  
2862562



STEALTH  
2862560

## 509 MX6 OFF-ROAD GOGGLE

SUPER WIDE FIELD OF VIEW, ENGINEERED FOR DIRT



### FEATURES

- PC outer lens with anti-scratch coating, and internal anti-fog coating
- Outriggers with latch system for quick lens change
- 45mm strap with silicone to hold strap in place



BLACK  
2862557



RED/BLACK  
2862558





**RED/GRAY**  
S-3XL | 2833029

**BLACK**  
S-3XL | 2861432

**FORCE PUFFER JACKET**

PACKABLE JACKET OFFERS LIGHTWEIGHT PROTECTION, IDEAL FOR ANY ACTIVITY

- 140g 3M<sup>®</sup> Thinsulate<sup>®</sup>
- Plenty of storage with two external hand pockets and one internal media pocket
- Rugged YKK zippers
- Great for travel, compacts into pocket



**ORANGE**  
S-3XL | 2833027

**BLUE**  
S-3XL | 2833028

**BLACK**  
S-3XL | 2861434

**SOFTSHELL JACKET**

VERSATILE LIGHTWEIGHT JACKET THAT'S PERFECT FOR EVERYDAY WEAR

- Casual jacket armed with rugged and warm features for everyday wear
- Superior DWR prevents precipitation from saturating the jacket's exterior
- Lined with soft fleece for warmth
- Removable hood and underarm venting, three external pockets and one internal chest pocket



**BLACK**  
S-3XL | 2862569

**NAVY**  
S-3XL | 2862570

**WORK VEST**

RUGGED AND DURABLE VEST THAT'S IDEAL AS AN OUTDOOR LAYER

- Made of durable nylon fabric to make it the ideal vest for work
- 80g 3M<sup>®</sup> Thinsulate<sup>®</sup> Insulation provides great warmth
- Vest comes with plenty of pockets to store your valuables



**GRAY**  
S-3XL | 2860863

**BLACK**  
S-3XL | 2861608

**WORK JACKET**

WARM AND RUGGED JACKET THAT'S TOUGH FOR WORK AND STYLISH FOR PLAY

- Coated with Durable Water Repellency (DWR) to provide water-resistance
- Built in action back for increased range of motion
- 80g 3M<sup>®</sup> Thinsulate<sup>®</sup> for added warmth with brushed flannel trim
- One inner and four outer pockets for storage

**REVOLVE VEST**

REVERSIBLE

DURABLE AND WARM REVERSIBLE VEST OFFERS TWO STYLES IN ONE

- Durable windbreak outer fabric helps protect from the elements
- 140g 3M<sup>®</sup> Thinsulate<sup>®</sup> insulation keeps you warm in cold weather
- Reversible vest offers two unique styles in one



**RED**  
S-3XL | 2833030

**BLACK/GRAY**  
S-3XL | 2862565

**WINDBREAKER JACKET**

LIGHTWEIGHT, WINDPROOF JACKET THAT PROVIDES PROTECTION WHILE RIDING

- 100% polyester windproof fabric
- Lightweight construction makes it easy to pack
- Three external pockets allow for maximum storage



**BLACK**  
S-3XL | 2861541

**FLANNEL JACKET**

SHERPA FLEECE LINED JACKET DELIVERS EXCEPTIONAL WARMTH AND COMFORT

- Warm sherpa lined fleece material
- Insulation to keep you warm
- Plenty of storage for your valuables



**CHARCOAL**  
S-3XL | 2860865

**BRONZE**  
S-3XL | 2860864







STAMP HOODIE

**NEW** Green | S-3XL | 2833061  
 Black | S-3XL | 2862484  
 Navy | S-3XL | 2861500



CREW SWEATSHIRT

**NEW** Gray | S-3XL | 2833067  
 Black | S-3XL | 2862488  
 Navy | S-3XL | 2861497



ICON HOODIE

**NEW** Black/Red | S-3XL | 2833065  
 Gray | S-3XL | 2862487  
 Green | S-3XL | 2861495

APPAREL

RACING COLLECTION

JERSEYS & GLOVES  
 & HEATED APPAREL

HELMETS & GOGGLES

MEN'S APPAREL

BALL CAPS

CAMO APPAREL

WOMEN'S APPAREL

HOME  
 & COLLECTIBLES



TITAN MID-LAYER

**NEW** Red | S-3XL | 2833026  
 Black | S-3XL | 2862568  
 Blue/Orange | S-3XL | 2862567



NORTHSTAR MID-LAYER

**NEW** Black/Lime | S-3XL | 2833024  
 Tan | S-3XL | 2862450



JOURNEY HOODIE

**NEW** Navy | S-3XL | 2833066  
 Black | S-3XL | 2862489



ICON LONG SLEEVE

**NEW** Lime | S-3XL | 2833083  
 Gray/Red | S-3XL | 2862505  
 Black | S-3XL | 2861584



DASH LONG SLEEVE

**NEW** Black/Red | S-3XL | 2833082  
 Navy | S-3XL | 2861583  
 Black | S-3XL | 2861582



PERFORMANCE LONG SLEEVE

**NEW** Gray | S-3XL | 2833168  
 Black | S-3XL | 2862507



**NEW**  
 STAPLE HOODIE

Black | S-3XL | 2833068  
 Navy | S-3XL | 2833069  
 Green | S-3XL | 2833070



TECH FULL-ZIP HOODIE

**NEW** Red | S-3XL | 2833064  
 Gray | S-3XL | 2861493



ROGUE HOODIE

**NEW** Black | S-3XL | 2833062  
**NEW** Navy | S-3XL | 2833063  
 Gray | S-3XL | 2862485



ICON TEE

**NEW** Lime | S-3XL | 2833079  
 Green | S-3XL | 2862501  
 Black | S-3XL | 2861570



**NEW**  
 GRAPHIC TEE

Dark Gray | S-3XL | 2833086  
 Forest Green | S-3XL | 2833087



FLAG TEE

Navy | S-3XL | 2862500  
 White | S-3XL | 2862582



# BALL CAPS



**NEW**  
LEATHER PATCH HAT

Black | One Size | 2833129  
Gray | One Size | 2833130



**NEW**  
STAPLE CAP

Black | One Size | 2833127  
Navy | One Size | 2833128



HIGHLAND CAP

**NEW** Navy | One Size | 2833126  
Tan | One Size | 2860893  
Gray | One Size | 2862544



ELLIPSE PATCH TRUCKER HAT

Orange | One Size | 2833124  
Light Gray | One Size | 2862539  
Gray | One Size | 2861531  
Black | One Size | 2861533  
Navy | One Size | 2861532



CORE CAP

**NEW** Red | One Size | 2833123  
Gray | One Size | 2862594  
Navy | One Size | 2861523  
Black | One Size | 2861524



TONAL HAT

Black/Red | One Size | 2861526  
Navy | One Size | 2861525



**NEW**  
JOURNEY CAP

Black | One Size | 2833136  
Blue | One Size | 2833137



CHECKERED HAT

Blue | One Size | 2861520  
Black | One Size | 2861522  
Gray | One Size | 2861521



RETRO CAP

**NEW** Black | One Size | 2833125  
Navy | One Size | 2862538  
Gray/Red | One Size | 2869542  
Gray/Orange | One Size | 2861536

# CAMO APPAREL



CAMO SOFTSHELL JACKET

Camo | S-3XL | 2861543



MEN'S CAMO REVOLVE VEST

Camo | S-3XL | 2862572



MEN'S CAMO PURSUIT HOODIE

Camo | S-3XL | 2862494



WOMEN'S CAMO PURSUIT HOODIE

Camo | S-3XL | 2862517



**NEW**  
PURSUIT HOODIE

Black | S-3XL | 2833076  
Green | S-3XL | 2833077



CAMO NECK GAITER

Camo | One Size | 2861948



STEALTH CAMO HAT

Camo | One Size | 2861527



HUNTER ORANGE HAT

Orange | S/M | 2860892  
Orange | L/XL | 2862545



HUNTER ORANGE BEANIE

Orange | One Size | 2862595

APPAREL

RACING COLLECTION

JERSEYS & GLOVES  
& HEATED APPAREL

HELMETS & GOGGLES

MEN'S APPAREL

BALL CAPS

CAMO APPAREL

WOMEN'S APPAREL

HOME  
& COLLECTIBLES





**NEW**  
**RADIANT GREEN** | S-3XL | 2833039  
**BLACK** | S-3XL | 2862457

**REVOLVE VEST**

DURABLE AND WARM REVERSIBLE VEST OFFERS TWO STYLES IN ONE

- Durable windbreak outer fabric protects you from the elements
- 140g 3M™ Thinsulate™ insulation keeps you warm in cold weather
- Reversible for two unique styles in one



**NEW** **BLACK** | S-3XL | 2833041  
**NEW** **RADIANT GREEN** | S-3XL | 2833040  
**BLUE** | S-3XL | 2862460

**SOFTSHELL JACKET**

VERSATILE LIGHTWEIGHT JACKET THAT'S PERFECT FOR EVERYDAY WEAR

- Casual jacket armed with rugged and warm features
- Superior DWR prevents precipitation from saturating the jacket's exterior
- Lined with 280g of soft fleece for warmth
- Removable hood and underarm venting
- Three external pockets and one internal chest pocket



**BLACK** | S-3XL | 2861433

**FORCE PUFFER JACKET**

PACKABLE JACKET OFFERS LIGHTWEIGHT PROTECTION AND INCREDIBLE WARMTH

- 140g 3M™ Thinsulate™
- Two external hand pockets, one internal media pocket
- Rugged YKK™ zippers
- Compactable into travel pocket



**BLACK** | S-3XL | 2862563  
**BLUE** | S-3XL | 2862564

**WORK JACKET**

WARM AND RUGGED JACKET THAT'S TOUGH FOR WORK AND STYLISH FOR PLAY

- 100% nylon shell is coated with DWR to help keep you dry
- 80g 3M™ Thinsulate™ for added warmth with brushed flannel trim
- Built-in action back for increased range of motion
- One inner and four outer pockets for storage



**NEW** **RADIANT GREEN** | S-3XL | 2833042  
**BLACK/GRAY** | S-3XL | 2862458

**TITAN MID-LAYER**

EXTREMELY WARM YET BREATHABLE MID-LAYER, PERFECT FOR RIDING

- 319g Polartec™ Thermal Pro™ Rib Sweater provides great warmth
- Breathable material moves sweat to the outer surface
- Nylon overlay is comfortable and light



**NEW**  
**STAPLE HOODIE**

Black | S-3XL | 2833095  
 Gray | S-3XL | 2833096



**JOURNEY HOODIE**

**NEW** Radiant Green | S-3XL | 2833098  
 Black | S-3XL | 2862515  
 Blue | S-3XL | 2862516



**TECH FULL-ZIP HOODIE**

**NEW** Black | S-3XL | 2833097  
 Maroon | S-3XL | 2861509  
 Gray | S-3XL | 2861508



**ICON HOODIE**

**NEW** Gray | S-3XL | 2833099  
 White | S-3XL | 2862512



**ADVENTURE CREW**

**NEW** Black/Radiant Green | S-3XL | 2833100  
**NEW** Green | S-3XL | 2833101  
 Dusty Rose | S-3XL | 2862513  
 Black | S-3XL | 2862514



**NEW**  
**ADVENTURE LONG SLEEVE**

Gray | S-3XL | 2833107  
 Navy | S-3XL | 2833108



**NEW**  
**CORE TANK**

Black | S-3XL | 2833161  
 Gray | S-3XL | 2833160



**NEW**  
**FLAG TEE**

Gray | S-3XL | 2833163  
 White | S-3XL | 2833162



**ADVENTURE TEE**

**NEW** Pink | S-3XL | 2833104  
 Black Frost | S-3XL | 2862628  
 Teal | S-3XL | 2862629

APPAREL

RACING COLLECTION

JERSEYS & GLOVES  
 & HEATED APPAREL

HELMETS & GOGGLES

MEN'S APPAREL

BALL CAPS

CAMO APPAREL

WOMEN'S APPAREL

HOME  
 & COLLECTIBLES





**RETRO CLOCK**  
91.4 cm | 2868662



**NEW**  
**POLARIS LED SIGN**  
91.4 cm x 35.6 cm | 2862736



**ALUMINUM SIGN**  
55.9 cm | 2860867



**WOOD SIGN**  
61 cm x 26.7 cm | 2860866



**RETRO GLASSES (SET OF 2)**  
2866265



**12oz CAMPER MUG**  
2861612



**23oz WATER BOTTLE**  
2862685



**WOODEN COASTERS**  
2860869



**HITCH COVER**  
2861623



**LICENSE PLATE HOLDER**  
2862687



**POLARIS PARKING SIGN**  
2869934



**POLARIS FLAG**  
5' x 3' | 2869928



**15oz CAMPFIRE MUG**  
2861613



**PREMIUM KOOZIE**  
2860829



**LEATHER LOOP KEYCHAIN**  
2861615



**KEYCHAIN**  
2861614



**KICKBACK ROCKER**  
2862626



**FREESTYLE ROCKER**  
2862625



**EASY CHAIR**  
2862627



**QUICK-E-SEAT**  
2862624



**FOLDABLE TABLE**  
2861620



**POP-UP TRASH BIN**  
2861622



**FLASK**  
2860812



**DECK OF CARDS**  
2860816



APPAREL

RACING COLLECTION

JERSEYS & GLOVES  
& HEATED APPAREL

HELMETS & GOGGLES

MEN'S APPAREL

BALL CAPS

CAMO APPAREL

WOMEN'S APPAREL

HOME  
& COLLECTIBLES



THE MOST CAPABLE UTV.  
**GET MORE DONE.**

Trusted by farmers, ranchers, hunters and homeowners for more than a decade.



Availability varies by market, check your local dealer for availability. Image taken on private land. The use of vehicles in similar environments in your jurisdiction may be prohibited per locally applicable laws and regulations. Campfire in similar environments in your jurisdiction may be prohibited per locally applicable laws and regulations. Keep your campfire safe, and make sure you can control it at all times. Know your locally applicable laws and regulations. Crossing water in similar environments may be prohibited in your jurisdiction.

Warning: Polaris off-road vehicles can be hazardous to operate and are not intended for on-road use. Driver must be at least 16 years old with a valid driver's license to operate. All riders should always wear helmets, eye protection and protective clothing and footwear. Read, understand and follow your owner's manual. Ride within the limits of your own abilities and never engage in stunt or exhibition driving. Never ride under the influence of drugs or alcohol. All riders should take a safety training course. Call 800-342-3764 for additional information.

Unless noted, trademarks are the property of Polaris Industries Inc. 3M® and Thinsulate® are registered trademarks of 3M Company. 509® is a registered trademark of Teton Outfitters, LLC. App Store® is a registered trademark of Apple Inc. BatteryMINDER® is a registered trademark of VDC Electronics Inc. Bluetooth® is a registered trademark of Bluetooth Sig, Inc. Caliber® is a trademark of Caliber, Inc. Carhartt® is a registered trademark of Carhartt, Inc. Facebook™ is a service trademark of Facebook, Inc. FidoLock® is a registered trademark of FidoLock GmbH. FOX® is a registered trademark of Fox Factory Inc. Google Play™ is a service trademark of GOOGLE LLC. GoPro® is a registered trademark of GoPro Inc. Homelink® is a registered trademark of Genlex Corporation. Instagram™ is a service trademark of Instagram, LLC. JBL® is a registered trademark of HARMAN INTERNATIONAL INDUSTRIES, INCORPORATED. KOLPIN® and KOLPIN STRONGHOLD® are registered trademarks of Polaris Industries Inc. MB Quart® is a registered trademark of Maxxsonics USA Inc. MORFLEX® is a registered trademark of FNA Group, Inc. NOCO Genius® is a registered trademark of The Noco Company. Otter® is a registered trademark of Otter Outdoors, LLC. Polartec® is a registered trademark of MMI-IPCO, LLC. Rhino Grip® is a registered trademark of Polaris Industries, Inc. RHINO-RACK® is a registered trademark of Rhino Rack Australia Pty Limited. RIGID® is a trademark of JST Performance, LLC d/b/a Rigid Industries LLC. SMART BOARD® is a registered trademark of SMART TECHNOLOGIES ULC UNLIMITED LIABILITY CORPORATION CANADA. Tiger Drylac® is a registered trademark of Tiger Coatings GMBH & CO. KG. TEKVEST® is a registered trademark of 1181676 ONTARIO INC. Twitter™ is a registered trademark of Twitter, Inc. WALKER EVANS RACING® is a registered trademark of Walker Evans Enterprises Incorporated. Yeti® is a registered trademark of Yeti Coolers, LLC. YKK® is a registered trademark of YKK Corporation. YouTube® is a registered trademark of Google LLC. Prices, fitment and availability are subject to change at any moment. Copyright © 2022 Polaris Industries Inc. All rights reserved.



# HARDEST WORKING.

SMOOTHEST RIDING.



**POLARIS**  
Think Outside

MY23 RGR APP ACC EMEA